

ODDER

3670611
3670612
93307001
93298001

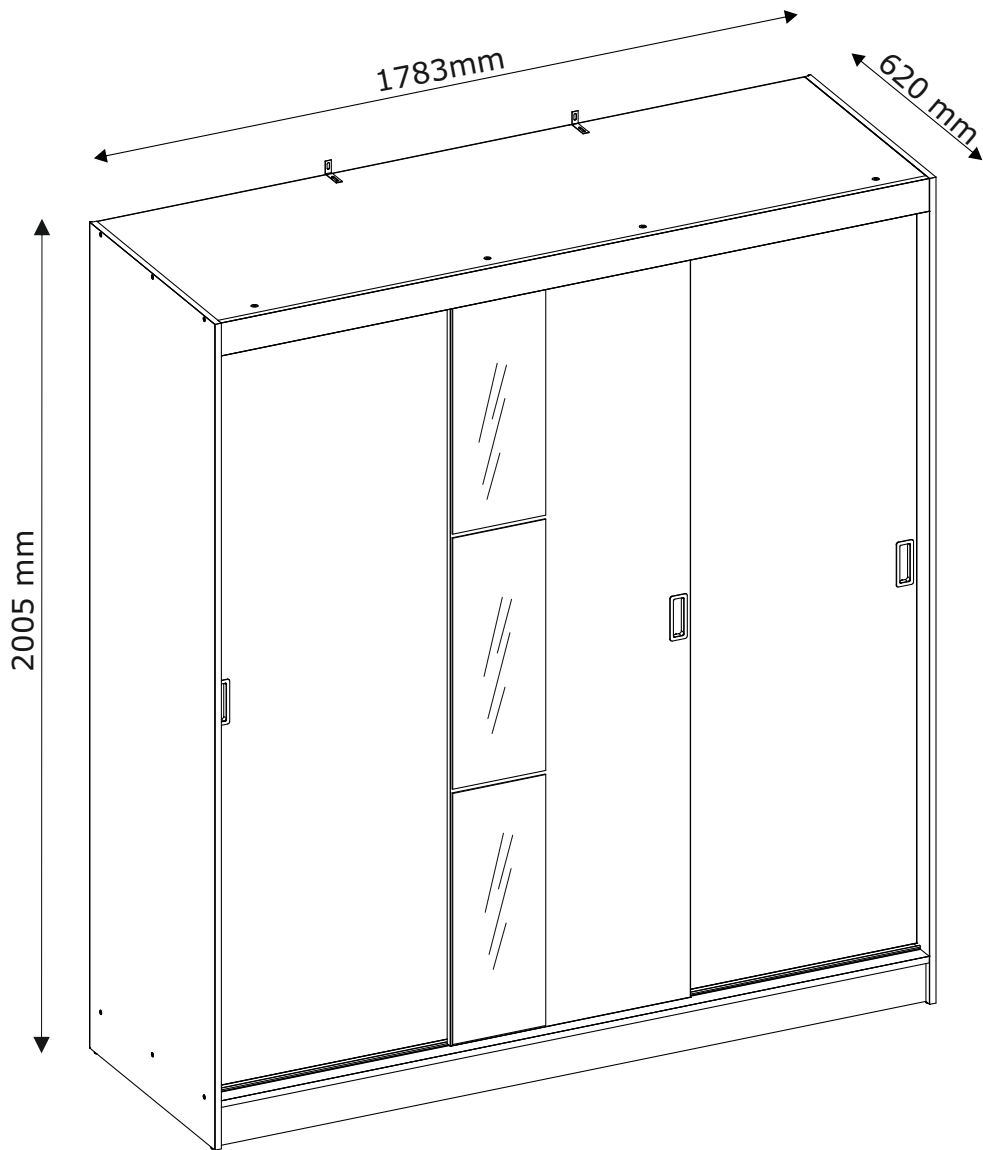

Pensez à donner ou recycler.



Association



Magasin



Déchèterie

<https://quefairedemesdechets.fr>

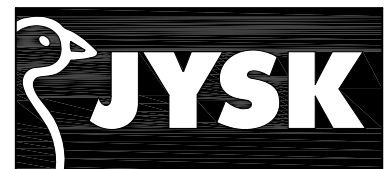

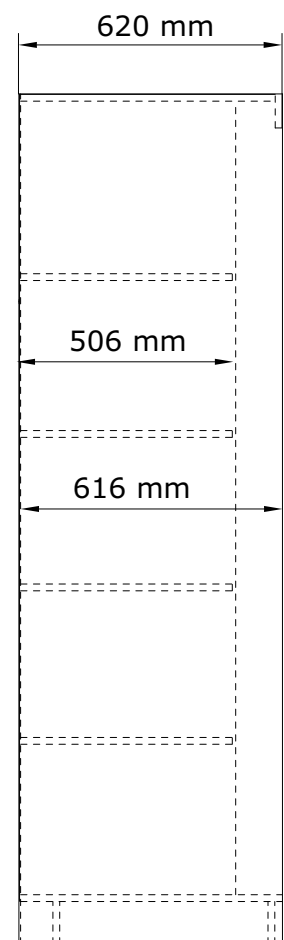
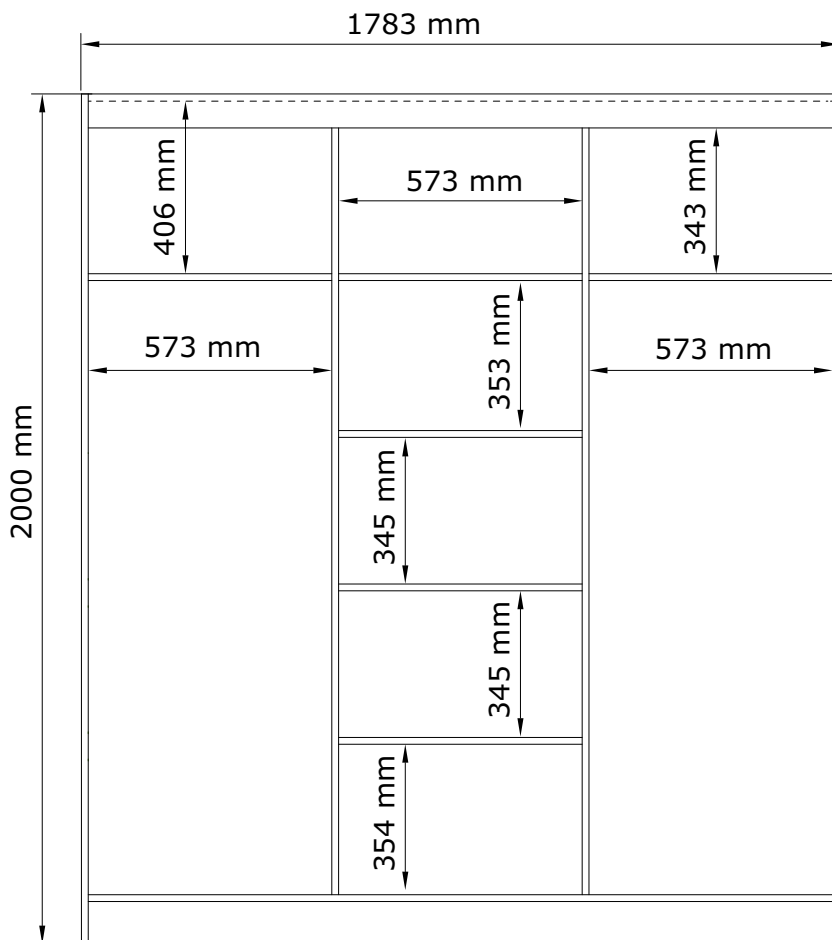
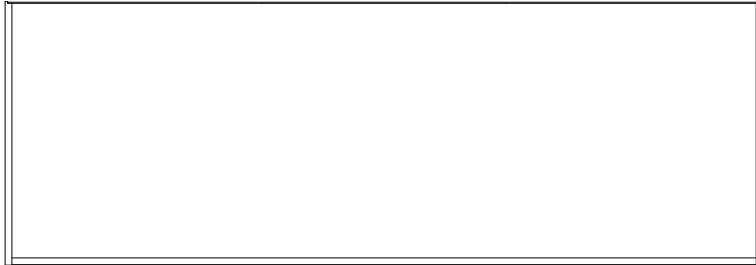

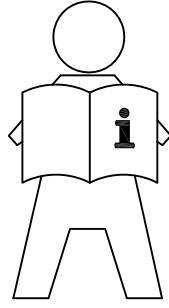
**GB IMPORTANT INFORMATION!**

Please read the entire manual carefully before starting to assemble and/or using this product. Follow the manual thoroughly and keep it for further reference.

DK VIGTIG INFORMATION!

Læs hele manualen grundigt igennem før samling og/eller brug af dette produkt. Følg manualen nøje, og opbevar den til senere brug.

DE WICHTIGE INFORMATIONEN!

Bitte lesen Sie die gesamte Anleitung sorgfältig durch, bevor Sie mit der Montage und/oder Verwendung dieses Produkts beginnen. Befolgen Sie die Anleitung genau und bewahren Sie diese für den späteren Gebrauch auf.

NO VIKTIG INFORMASJON!

Les hele bruksanvisningen nøye før du begynner å montere og/eller bruke dette produktet. Følg bruksanvisningen nøye, og ta vare på den for fremtidig bruk.

SE VIKTIG INFORMATION!

Läs bruksanvisningen i sin helhet innan du börjar att montera och/eller använda produkten. Följ bruksanvisningen noggrant och spara den för framtida referens.

FI TÄRKEITÄ TIETOJA

Lue käyttöohjeet kokonaan ennen tämän tuotteen kokoamista ja/tai käyttöä. Noudata käyttöohjeita tarkasti ja säilytä ne myöhempää tarvetta varten.

PL WAŻNE INFORMACJE.

Przed użyciem produktu należy dokładnie zapoznać się ze wskazówkami bezpieczeństwa. Należy zapoznać się z instrukcją obsługi i zachować ją do użytku w przyszłości.

CZ DŮLEŽITÉ INFORMACE!

Před sestavením nebo použitím výrobku si pečlivě přečtěte celý návod. Dodržujte důsledně uvedené pokyny a návod uschovejte, aby byl k dispozici v případě potřeby.

HU FONTOS INFORMÁCIÓ

A termék összeszerelésének vagy használatának megkezdése előtt figyelmesen olvassa el a teljes útmutatót. Őrizze meg az útmutatót, és gondosan tartsa be a benne foglaltakat.

NL BELANGRIJKE INFORMATIE!

Lees de volledige handleiding zorgvuldig door voordat u dit product monteert en/of gebruikt. Volg de handleiding zorgvuldig en bewaar deze voor toekomstig gebruik.

SK DŮLEŽITÉ INFORMÁCIE!

Predtým ako začnete s montážou a/alebo používaním tohto produktu si pozorne prečítajte celý návod. Návod dôsledne dodržiavajte a ponechajte si ho pre použitie v budúcnosti.

FR INFORMATIONS IMPORTANTES

Veuillez lire attentivement l'ensemble du manuel avant de commencer à monter et/ou utiliser ce produit. Suivez rigoureusement le manuel et conservez-le pour toute consultation ultérieure.

SI POMEMBNE INFORMACIJE!

Pred montažo/uporabo izdelka pozorno preberite ta navodila za uporabo. Upoštevajte navodila in jih shranite, saj jih boste morda še potrebovali.

HR VAŽNE OBAVJESTI!

Molimo Vas pažljivo pročitajte upute za uporabu prije sastavljanja i/ili korištenja ovog proizvoda. Strogo se pridržavajte uputa i sačuvajte ih za buduće potrebe.

IT INFORMAZIONI IMPORTANTI!

Si prega di leggere attentamente l'intero manuale prima di cominciare a montare e/o a utilizzare questo prodotto. Seguire rigorosamente le istruzioni di questo manuale e conservarlo per una successiva consultazione.

ES INFORMACIÓN IMPORTANTE

Leer con atención todo el manual antes de comenzar a ensamblar/usar este producto. Seguir a conciencia las instrucciones del manual y conservarlo para futuras consultas.

BA VAŽNE INFORMACIJE!

Prije sklapanja i/ili korištenja ovog proizvoda, pažljivo pročitajte cijeli priručnik. Pažljivo se pridržavajte uputstva u priručniku i sačuvajte ga za buduću upotrebu.

RS VAŽNE INFORMACIJE!

Pažljivo pročitajte kompletan priručnik pre nego što počnete da sklapate i/ili koristite ovaj proizvod. Detaljno sledite priručnik i sačuvajte ga za kasniju upotrebu.

UA ВАЖЛИВА ІНФОРМАЦІЯ.

Уважно прочитайте весь посібник, перш ніж збирати та/чи використовувати цей продукт. Виконайте всі інструкції цього посібника та збережіть його для подальшого використання.

RO INFORMAȚII IMPORTANTE

Citiți cu atenție întregul manual înainte de a începe să montați și/sau să utilizați acest produs. Urmați îndeaproape instrucțiunile din manual și păstrați-l pentru consultare ulterioară.

BG ВАЖНА ИНФОРМАЦИЯ!

Моля, прочетете цялото ръководство внимателно, преди да започнете да сглобявате и/или използвате този продукт. Следвайте стриктно ръководството и го пазете за бъдещи справки.

GR ΣΗΜΑΝΤΙΚΕΣ ΠΛΗΡΟΦΟΡΙΕΣ!

Διαβάστε προσεκτικά ολόκληρο το εγχειρίδιο πριν από τη συναρμολόγηση ή/και τη χρήση του προϊόντος. Ακολουθήστε προσεκτικά τις οδηγίες του εγχειριδίου και κρατήστε τις για μελλοντική αναφορά.

PT INFORMAÇÕES IMPORTANTES!

Queira ler este manual inteiro e com atenção antes de começar a montar e/ou usar este produto. Siga as instruções de forma cuidadosa e guarde-as para referência futura.

RU ВАЖНАЯ ИНФОРМАЦИЯ!

Внимательно и полностью прочитайте это руководство, прежде чем приступать к сборке или использованию этого изделия. Следуйте всем инструкциям этого руководства и сохраните его на будущее для справки.

TR ÖNEMLİ BİLGİLER!

Bu ürünün montajını yapmaya başlamadan ve/veya ürünün kullanmadan önce lütfen kılavuzun tamamını dikkatlice okuyun. Kılavuzu adım adım izleyin ve daha sonra başvurmak üzere saklayın.

CN 重要信息!

组装和/或使用本产品之前请通读该手册。请严格遵循手册说明，保留手册供日后参考。

AR **إرشادات مهمة!**

يرجى قراءة الدليل بأكمله بعناية قبل البدء في تجميع و/أو استخدام هذا المنتج. اتبع ما ورد في الدليل بالكامل واحفظه للرجوع إليه في المستقبل.

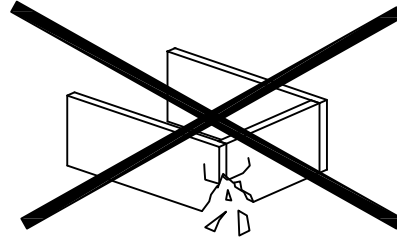
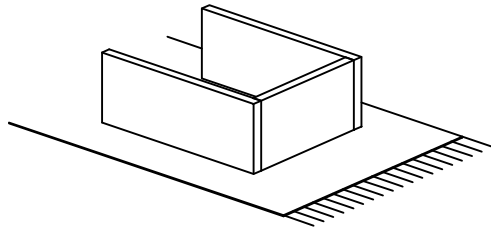

GB WARNING TO AVOID SCRATCHES!

In order to avoid scratching this furniture should be assembled on a soft layer - could be a rug.

DK ADVARSEL FOR AT FORHINDRE RIDSER!

For at forhindre ridser skal dette møbel samles på et blødt underlag, f.eks. et tæppe.

DE HINWEIS ZUR VERMEIDUNG VON KRATZERN

Um Kratzer zu vermeiden, sollte dieses Möbelstück auf einer weichen Unterlage montiert werden (z. B. Teppich).

NO ADVARSEL FOR Å UNNGÅ RIPER!

For å unngå riper må møbelet monteres på et mykt underlag, for eksempel et teppe.

SE VARNING OM HUR DU UNDVIKER REPOR!

För att undvika repor ska denna möbel monteras på ett mjukt underlag, exempelvis en matta.

FI VARO NAARMUJA!

Varo naarmuja ja kokoa tämä kaluste pehmeällä alustalla, esimerkiksi maton päällä.

PL OSTRZEŻENIE WS. USZKODZEN

Aby uniknąć rys, ten mebel powinien być montowany, składany na miękkim podłożu, np. dywanie.

CZ VAROVÁNÍ TÝKAJÍCÍ SE POŠKRÁBÁNÍ!

Aby nedošlo k poškrábání, sestavujte nábytek na měkkém podkladu – např. na koberec.

HU KARCOLÁSOK MEGELŐZÉSE – FIGYELEM!

A karcolások megelőzése érdekében a bútort puha felületen, például szőnyegen kell összerakni.

NL WAARSCHUWING OM KRASSEN TE VERMIJDEN!

Om te voorkomen dat dit meubel krassen vertoont, moet het gemonteerd worden op een zachte ondergrond - zoals een tapijt

SK VÝSTRAHA TÝKAJÚCA SA PREDCHÁDZANIA ŠKRABANCOM!

Aby sa predišlo škrabancom, tento nábytok by sa mal montovať na mäkkom podklade, napríklad na koberec.

FR AVERTISSEMENT POUR ÉVITER LES RAYURES

Afin d'éviter les rayures, ce meuble doit être monté sur une surface souple (un tapis, par exemple).

SI KAKO PREPREČITI PRASKE!

Da bi se izognili praskam na pohištvu, pohištvo sestavite na mehki podlagi, npr. na preprogi

HR UPOZORENJE O IZBJEGAVANJU OGREBOTINA!

Kako bi se izbjegle ogrebotine, ovaj proizvod potrebno je sastavljati na mekanoj površini - primjerice, na tepihu.

IT AVVERTENZA PER EVITARE I GRAFFI!

Per evitare i graffi, si raccomanda di montare questo mobile su una superficie morbida (come ad es. un tappeto).

ES ADVERTENCIA PARA EVITAR RAYADURAS

Para no rayar este mueble, es aconsejable ensamblarlo sobre una superficie suave (posiblemente una alfombra).

BA UPOZORENJE ZA SPRJEČAVANJE NASTANKA OGREBOTINA!

Da bi se izbjegle ogrebotine na ovom namještaju, poželjno ga je sastaviti na mekoj podlozi - na primjer, tepihu.

RS UPOZORENJE ZA IZBEGAVANJE OGREBOTINA!

Da biste izbegli ogrebotine, ovaj nameštaj treba da sastavljate na mekoj podlozi - može prostirka.

UA ПОПЕРЕДЖЕННЯ ЩОДО ПОДРЯПИН.

Щоб уникнути подряпин, ці меблі слід збирати на м'якій поверхні, наприклад, на килимі.

RO ATENȚIONARE PENTRU EVITAREA ZGĂRIERII!

Pentru evitarea zgărierii, această piesă de mobilier trebuie să fie montată pe o suprafață moale, de exemplu, pe un covor.

BG ПРЕДУПРЕЖДЕНИЕ ЗА ИЗБЯГВАНЕ НА ДРАСКОТИНИ!

За да избегнете надраскване, тази мебел трябва да бъде сглобена на мека повърхност – например килим.

GR ΠΡΟΕΙΔΟΠΟΙΗΣΗ ΓΙΑ ΤΗΝ ΑΠΟΦΥΓΗ ΓΡΑΤΣΟΥΝΙΩΝ!

Για την αποφυγή γρατσουνιών, το έπιπλο θα πρέπει να συναρμολογηθεί σε μαλακή επιφάνεια, όπως για παράδειγμα πάνω σε ένα χαλί.

PT AVISO PARA EVITAR RISCOS

Para evitar riscos, este móvel deve ser montado numa superfície macia (por exemplo, tapete).

RU ПРЕДУПРЕЖДЕНИЕ ОТНОСИТЕЛЬНО ЦАРАПИН!

Во избежание нанесения царапин, сборку этой мебели необходимо выполнять на мягкой поверхности, например на ковре.

TR ÇİZİLMELERİ ÖNLEMEYE YÖNELİK UYARI!

Bu mobilyanın çizilmesini engellemek için montajını halı gibi yumuşak bir yüzeyin üzerinde yapın.

CN 防刮警告!

为了避免刮伤家具，应在地毯等软面上进行组装。

AR حذير لتجنب الخدوش!

لتجنب الخدوش، ينبغي تجميع قطعة الأثاث هذه على طبقة ناعمة - قد تكون قطعة سجاد.

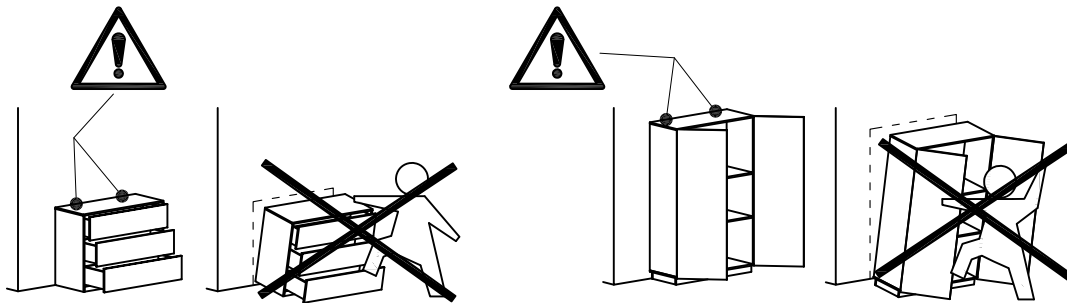

GB ANTI-TOPPLE WARNING!

This product has to be permanently fixed to the wall with the bracket(s) included, to avoid fatal injury in case it topples over. The pack only contains screws for fastening the anti-topple bracket(s) itself to the product. Please contact your DIY or hardware store for advice on the correct type of screws/raw plugs for your type of wall.

DK ADVARSEL VEDRØRENDE VÆLTESIKRING!

Dette produkt skal fastgøres permanent til væggen med det eller de medfølgende beslag for at forhindre livsfarlige skader, hvis produktet vælter. Pakken indeholder kun skruer til fastgørelse af væltesikringsbeslaget eller -beslagene til selve produktet. Kontakt dit lokale byggemarked eller din isenkrammer for vejledning om den korrekte type af skruer/rawplugs til netop din type væg.

DE ACHTUNG KIPPGEFAHR!

Dieses Produkt muss mit der/den mitgelieferten Halterung(en) dauerhaft an der Wand befestigt werden, um tödliche Verletzungen im Falle eines Umkippens zu vermeiden. Die Verpackung enthält lediglich Schrauben zur Befestigung der Kippschutzhalterung(en) am Produkt. Für Informationen zur richtigen Schrauben-/Dübelart für Ihren Wandtyp wenden Sie sich bitte an Ihren Baumarkt.

NO ADVARSEL, VELTEFARE!

Dette produktet må festes permanent til veggen med medfølgende brakett(er) for å hindre at det velter og forårsaker skade. Pakken inneholder bare skruer for å feste veltesikringsbraketten(e) til produktet. Rådfor deg med en jernvarehandel for å finne egnede skruer/plugger til den aktuelle veggen.

SE TIPP-VARNING!

Denna produkt måste fästas vid väggen med bifogat fäste/bifogade fästen för att undvika att den tippar och faller över ända, och på så sätt orsakar allvarliga personskador inklusive dödsfall. Förpackningen innehåller endast skruvar för fästsättning av fästet/fästena på produkten. Kontakta en järnaffär eller ett byggvaruhus för råd om rätt typ av skruv/plugg för den typ av vägg du har.

FI KAATUMISVAARA!

Tämä tuote on kiinnitettävä seinään mukana toimitetuilla kiinnikkeillä kohtalokkaiden vammojen välttämiseksi tuotteen mahdollisesti kaatuessa. Pakkaus sisältää vain kiinnitysruuvit kaatumista estävien kiinnikkeiden kiinnittämiseksi tuotteeseen. Rautakaupasta saa lisätietoa seinämateriaalin vaatimista ruuveista ja tulpista.

PL OSTRZEŻENIE PRZED WYWRÓCENIEM SIĘ

Produkt musi być na stałe przymocowany do ściany dołączonymi uchwytami, aby uniknąć śmiertelnego wypadku, gdy się przewróci. W pakiecie są tylko śruby pozwalające na przykręcenie uchwytów do produktu, które zapobiegają przewróceniu się produktu. Prosimy o skontaktowanie się z specjalistycznym sklepem lub fachowcem w sprawie śrub lub kołków, które należy zastosować do danego typu ściany.

CZ VAROVÁNÍ TYKAJÍCÍ SE SKLOPENÍ!

Tento výrobek musí být trvale připevněn na stěnu pomocí přiložených držáků, aby nedošlo ke smrtelnému zranění, kdyby se sklopil. Sada obsahuje pouze šroubky pro upevnění držáků zabírajících sklopení k výrobku. Ohledně správného typu vrtůl/hmoždinek pro daný typ stěny se obraťte na vhodný obchod nebo železářství.

HU BORULÁS VESZÉLYE – FIGYELEM!

A termékét fixen rögzíteni kell a falhoz a mellékelt tartóelem(ek) segítségével. Ellenkező esetben halálos sérülést okozhat, ha felborul. A csomag csak a borulásgátló tartóelem(ek)nek a termékhez való rögzítésére szolgáló csavarokat tartalmazza. Érdeklődjön a DIY boltban vagy egy barkácsboltban, hogy milyen a megfelelő csavar, illetve tipli az adott faltípushoz.

NL WAARSCHUWING KANTELBEVEILIGING!

Dit product moet met de haak/haken permanent bevestigd worden aan de muur om verwondingen met dodelijke afloop te voorkomen indien deze omkantelt. De verpakking bevat enkel schroeven om de haken voor kantelbeveiliging op het product vast te maken. Contacteer uw doe-het-zelfzaak of bouwmarkt voor advies over het correcte type schroeven/rawplugs voor uw soort muur.

SK VÝSTRAHA PRED PREVRÁTENÍM!

Tento produkt musí byť natrvalo pripevnený k stene pomocou dodanej(-ých) konzoly (konzol), aby sa predišlo smrteľnému úrazu v prípade, že sa prevráti. Balenie obsahuje iba skrutky, ktorými sa pripevňujú k produktu samotné konzoly chrániace pred prevrátaním. Kontaktujte miestnu predajňu pre domáciach majstrov alebo železiarstvo, kde vám poradia ohľadom správneho typu skrutiek/príchytiek pre váš typ steny.

FR AVERTISSEMENT ANTIBASCULEMENT

Ce produit doit être fixé de manière permanente au mur à l'aide du/des support(s) inclus afin d'éviter des blessures mortelles en cas de basculement. L'emballage contient des vis pour attacher le(s) support(s) antibasculement au produit. Veuillez contacter votre magasin de bricolage ou votre quincaillerie pour obtenir des conseils sur le type de vis/chevilles adapté à votre mur.

SI OPOZORILO O ZAŠČITI PRED PREVRNITVIJO!

Ta izdelek je treba s priloženimi nosilci trajno pritrditi na steno, da se izognete smrtnim poškodbam v primeru prevrnitve iz delka. Paket vsebuje le vijake za pritrditev zaščitnih nosilcev na izdelek. Strokovnjaka ali trgovino z opremo za dom povprašajte za nasvet glede pravičnega tipa vijakov/zidnih vložkov, ki so najbolj primerni za uporabo na vaši steni.

HR UPOZORENJE O ZAŠTITI OD PREVRTANJA!

Proizvod mora biti trajno učvršćen na zid s pomoću isporučenih nosača kako bi se u slučaju prevrtanja proizvoda izbjegle smrtonosne ozljede. S proizvodom se isporučuju samo vijci za pričvršćivanje zaštitnih nosača na proizvod. Molimo Vas da od svog prodavača zatražite savjet o vrsti vijaka/tipli koje su najprikladnije za Vaš zid.

IT AVVERTENZA ANTICADUTA DI COMPONENTI!

Questo prodotto deve essere fissato alla parete con i/i suo/i supporto/i in modo permanente per evitare lesioni gravi in caso di sua caduta. L'imballaggio contiene solo viti per il fissaggio al prodotto del/i supporto/i anticaduta. Si prega di contattare il proprio negozio di bricolage o ferramenta per farsi consigliare il tipo corretto di viti o tasselli ad espansione per il proprio tipo di muro.

ES ADVERTENCIA ANTIVUELCO

Este producto se debe fijar permanentemente a la pared usando los soportes incluidos, para evitar así accidentes fatales en caso de vuelco. El embalaje solo contiene los tornillos para fijar los soportes antivuelco al producto. Pide asesoramiento sobre los tornillos y tacos adecuados para tu tipo de pared en una tienda de bricolaje o ferretería.

BA UPOZORENJE ZA SPRJEČAVANJE PREVRTANJA!

Ovaj proizvod je potrebno trajno fiksirati na zid koristeći priloženi nosač(e), kako bi se izbjegle ozbiljne ozljede u slučaju njegovog prevrtanja. U pakovanju su priloženi samo vijci za pričvršćivanje nosača na proizvod. Savjet vezano za vijke/tiple prikladne za vaš zid, potražite u lokalnoj DIY trgovini ili željezariji.

RS UPOZORENJE O OPASNOSTI OD PADA!

Ovaj proizvod mora stalno da bude pričvršćen za zid držačem (držačima) iz pakovanja, da bi se izbjegla smrtonosna povreda u slučaju da proizvod padne. Pakovanje sadrži samo šrafove za pričvršćivanje na proizvod držača protiv padanja. Kontaktirajte prodavnicu "Uradi sam" ili gvoždarsku radnju za savet o ispravnoj vrsti šrafova/tiplova za tip zida koji imate.

UA ПОПЕРЕДЖЕННЯ ЩОДО ПЕРЕКИДАННЯ ПРОДУКТУ.

Цей продукт необхідно надійно прикріпити до стіни за допомогою кронштейнів, що входять до комплекту поставки. Це дозволить запобігти важких травмувань у разі перекидання продукту. До комплекту входять тільки гвинти для кріплення до продукту кронштейнів, що запобігають падінню. Зверніться до співробітників магазину побутових товарів або обладнання, щоб підібрати правильний тип гвинтів/дюбелів, які підходять до ваших стін.

RO ATENȚIONARE PENTRU PREVENIREA RĂSTURNĂRII!

Produsul trebuie fixat permanent pe perete cu ajutorul suporturilor incluse, pentru evitarea accidentărilor fatale, în cazul în care acesta se răstoarnă. Pachetul conține numai șuruburile necesare pentru fixarea pe produs a suporturilor pentru prevenirea răsturnării. Contactați magazinul de bricolaj sau de articole de mobilier pentru sfaturi referitoare la tipul corect de șuruburi/dubluri pentru tipul dvs. de perete.

BG ПРЕДУПРЕЖДЕНИЕ ПРОТИВ ПАДАНИЯ!

Този продукт трябва да бъде трайно монтиран на стената с помощта на включената скоба (или скоби), за да се избегнат смъртоносни наранявания, в случай че той падне. Пакетът съдържа само винтове за фиксиране на скобата (или скобите) против падане за продукта. Моля, попитайте в магазин за бита или железарски магазин за съвет относно подходящия тип винтове/дюбели за вашата тип стена.

GR ΠΡΟΕΙΔΟΠΟΙΗΣΗ ΣΥΓΚΡΑΤΗΣΗΣ!

Το προϊόν πρέπει να είναι πάντοτε στερεωμένο στον τοίχο, με τα στηρίγματα που παρέχονται, για την αποφυγή σοβαρού τραυματισμού σε περίπτωση ανατροπής. Στη συσκευασία περιέχονται μόνο βίδες για τη στερέωση των στηριγμάτων συγκράτησης του προϊόντος. Για βοήθεια σχετικά με τις βίδες/βύσματα που είναι κατάλληλα για τον τοίχο σας, απευθυνθείτε σε κάποιον ειδικό ή σε κατάστημα τέτοιων υλικών.

PT ATENÇÃO, PERIGO DE TOMBAR!

Este produto deve ser fixado de forma permanente à parede com o(s) suporte(s) fornecido(s), para evitar ferimentos fatais em caso de tombamento. A embalagem contém apenas parafusos para fixar o(s) suporte(s) anti basculante(s) ao produto. Para obter informações sobre os parafusos/buchas indicados para o seu tipo de parede, entre em contato com sua loja de bricolage.

RU ПРЕДУПРЕЖДЕНИЕ ОБ ОПРОКИДЫВАНИИ!

Во избежание опрокидывания это изделие должно быть надежно прикреплено к стене с помощью прилагаемых кронштейнов. В комплект входят винты только для прикрепления кронштейнов к самому изделию. Шурупы и дюбели для крепления к стене конкретного типа можно найти в строительном или хозяйственном магазине.

TR DEVRİLMEME KARŞI KORUYUCU DESTEĞE YÖNELİK UYARI!

Devrilip düşme sonucu ortaya çıkabilecek ölümcül yaralanmaları önlemek üzere bu ürün, devrilmeye karşı koruyucu destekleriyle birlikte duvara kalıcı olacak şekilde sabitlenmelidir. Pakette yalnızca devrilip düşmeye karşı koruyucu desteği ürüne sabitleyecek vidalar bulunmaktadır. Duvarınızın tipine özgü vida/dübel tipiyle ilgili doğru bilgi için lütfen yapı marketinize veya nalbur dükkanınıza danışın.

CN 防翻倒警告!

本产品必须使用提供的支架固定到墙上，以免翻倒造成致命伤害。产品包装内只含有将防翻倒支架与产品固定在一起的螺钉。请与 DIY 或五金店联系，咨询适合您墙面的螺钉/螺柱。

AR تحذير من السقوط!

يجب تثبيت هذا المنتج بشكل دائم على الحائط باستخدام الدعامة المرفقة (واحدة كانت أو أكثر). لتجنب الإصابة المميتة في حالة سقوطه. تحتوي العبوة فقط على براغي لتثبيت الدعامة المانعة للسقوط نفسها (واحدة كانت أو أكثر) بالمنتج. يرجى الاتصال بمتجر الأجهزة أو محل بيع الأجهزة لديك للحصول على المشورة بشأن النوع المناسب من البراغي/المثبت (الخابور) لنوع الحائط لديك.



GB GENERAL INSTRUCTION FOR FURNITURE SURFACES!

Wipe clean with a damp cloth. Use only water or a gentle detergent. Wipe dry with a clean cloth.

DK GENEREL VEJLEDNING TIL MØBLER!

Rengøres med en fugtig klud. Anvend kun vand eller et mildt vaskemiddel. Tørres af med en ren klud.

DE ALLGEMEINE HINWEISE FÜR MÖBEL!

Mit einem feuchten Tuch abwischen. Nur Wasser oder ein mildes Reinigungsmittel verwenden. Mit einem sauberen Tuch trocken reiben.

NO GENERELLE INSTRUKSJONER FOR MØBLER!

Tørk av med en fuktig klut. Bruk bare vann eller et mildt vaskemiddel. Tørk av med en ren klut.

SE ALLMÄNNA INSTRUKTIONER GÄLLANDE MÖBLER!

Torka rent med en fuktig trasa. Använd endast vatten eller ett mildt rengöringsmedel. Torka torrt med en ren trasa.

FI YLEISIÄ OHJEITA KALUSTEILLE!

Pyyhi puhtaaksi kostealla liinalla. Käytä vain vettä tai mietoä pesuainetta. Kuivaa puhtaalla liinalla.

PL OGÓLNE INSTRUKCJE DOTYCZĄCE MEBLI

Do czyszczenia należy używać wilgotnej ściereczki. Używać wyłącznie wody lub delikatnego detergentu. Wycierać do sucha ściereczką.

CZ OBECNÉ POKYNY TYKAJÍCÍ SE NÁBYTKU!

Čistěte otřením navlhčeným hadříkem. Používejte pouze vodu nebo jemný čistící prostředek. Vytřete dosucha čistým hadříkem.

HU ÁLTALÁNOS ÚTMUTATÁS A BÜTOROKHOZ

Törölje tisztára nedves ruhával. Csak vizet vagy kímélő tisztítószert használjon.

Törölje szárazra tiszta ruhával.

NL ALGEMENE INSTRUCTIES VOOR MEUBELS!

Reinig met een vochtige doek. Gebruik alleen water of wasmiddel. Droogwrijven met een schone doek.

SK VŠEOBECNÉ POKYNY PRE NÁBYTOK!

Utrite dočista navlhčenou utierkou. Používajte iba vodu alebo jemný čistiaci prostriedok. Utrite dosucha čistou utierkou.

FR INSTRUCTIONS GÉNÉRALES POUR LE MOBILIER

Nettoyer à l'aide d'un chiffon humide. Utiliser uniquement de l'eau ou un détergent doux. Essuyer à l'aide d'un chiffon propre.

SI SPLOŠNA NAVODILA ZA VZDRŽEVANJE POHISTVA!

Obrišite z vlažno krpo. Uporabljajte le vodo ali blag detergent. Posušite s čisto krpo.

HR OPĆE UPUTE ZA NAMJEŠTAJ IZRAĐEN!

Očistite vlažnom krpom. Upotrijebite samo vodu ili blagi deterđent. Posušite čistom krpom.

IT ISTRUZIONI GENERALI PER MOBILI!

Pulire con un panno umido. Utilizzare solo acqua o un detergente delicato. Asciugare con un panno pulito.

ES INSTRUCCIONES GENERALES ACERCA DE LOS MUEBLES

Limpiar con un paño húmedo. Usar solo agua o un detergente suave. Secar con un paño limpio.

BA OPŠTA UPUTSTVA ZA NAMJEŠTAJ.

Obrisati vlažnom krpom. Koristiti samo vodu ili blagi deterđent. Posušiti suhom krpom.

RS OPŠTA UPUTSTVA ZA NAMEŠTAJ NAPRAVLJEN!

Obrišite vlažnom krpom. Koristite samo vodu ili blagi deterđent. Prebrišite suvom, čistom krpom.

UA ЗАГАЛЬНА ІНСТРУКЦІЯ ДЛЯ МЕБЛІВ, ВИГОТОВЛЕНИХ.

Протирайте за допомогою вологої ганчірки. Використовуйте воду або слабкий розчин м'якого засобу. Витирайте чистою ганчіркою.

RO INSTRUCȚIUNI GENERALE PENTRU MOBILIER!

Curățați prin ștergere cu o lavetă umeză. Utilizați numai apă sau un detergent delicat. Uscați prin ștergere cu o lavetă curată.

BG ОБЩА ИНСТРУКЦИЯ ЗА МЕБЕЛИ, ИЗРАБОТЕНИ!

Избършете с влажна кърпа. Използвайте само вода или лек почистващ препарат. Подсушете с чиста кърпа.

GR ΓΕΝΙΚΕΣ ΟΔΗΓΙΕΣ ΓΙΑ ΕΠΙΠΛΑ!

Σκουπίστε με ένα υγρό πανί. Χρησιμοποιείτε μόνο νερό ή ένα ήπιο απορρυπαντικό. Στεγνώνετε με ένα καθαρό πανί.

PT INFORMAÇÕES GERAIS PARA MÓVEIS

Limpar com um pano úmido. Usar apenas água ou detergente neutro. Secar com um pano limpo.

RU ОБЩИЕ УКАЗАНИЯ ОТНОСИТЕЛЬНО МЕБЕЛИ!

Очистите изделие чистой влажной тканью. Используйте мягкодействующее моющее средство. Вытрите досуха чистой тряпкой.

TR MOBİLYALARA YÖNELİK GENEL YÖNERGE!

CN 家具表面的一般说明

请用湿布擦拭。只使用水或温和洗涤剂。

请用干净的布擦干。

AR شادات عامة السطح الأثاث
تسحق المسحوقه قماش مبله. ال تستخدم سوى الماء أو منظف خفيف.
مع المسحوقه قماش نظيفة.

GB IMPORTANT!

It is important that any product which is assembled using any kind of screw is re-tightened 2 weeks after assembly, and once every 3 months - in order to assure stability through-out the lifespan of the product.

DK VIGTIGT!

Det er vigtigt, at alle produkter, der samles med alle former for skruer, efterspændes to uger efter samling samt hver tredje måned for at sikre, at produktet er stabilt i hele dets levetid.

DE WICHTIG!

Es ist wichtig, bei jedem mit Schrauben montierten Produkt diese 2 Wochen nach dem Zusammenbau sowie einmal alle 3 Monate wieder anzuziehen, um die Stabilität des Produkts über die gesamte Lebensdauer hinweg zu gewährleisten.

NO VIKTIG!

Det er viktig at alle produkter som monteres med skruer blir etterstrammet 2 uker etter montering, og hver 3. måned for å sikre stabiliteten gjennom hele produktets levetid

SE VIKTIGT!

För alla produkter som monteras med skruv är det viktigt att dessa efterdras två veckor efter monteringen och därefter en gång var tredje månad. Detta för att säkerställa att produkten håller sig stabil under hela sin livslängd.

FI TÄRKEÄÄ!

On tärkeää, että kaikki ruuvien avulla koottavat tuotteet kiristetään uudelleen 2 viikkoa kokoamisen jälkeen ja aina 3 kuukauden välein, jotta tuote pysyy vakaana koko käyttöikänsä ajan.

PL WAŻNE!

Ważne jest, żeby każdy ze skreconych produktów został ponownie dokrecony w ciągu 2 tygodni od montażu, a następnie sprawdzać co 3 miesiące czy śruby są dokrecone — w celu zapewnienia stabilności przez czas użytkowania produktu.

CZ DŮLEŽITÉ!

U každého výrobku, který se sestavuje pomocí jakýchkoli šroubků, je důležité dotáhnout šroubky 2 týdny po sestavení a potom každé 3 měsíce, aby byla zajištěna stabilita po celou dobu životnosti výrobku.

HU FONTOS!

Minden termékénél fontos, hogy bármilyen fajta csavarral is történi az összeszerelése, utána 2 héttel, majd 3 havi rendszerességgel szükségés a csavarok utánhúzásá. Ezzel a termék teljes élettartamán keresztül biztosítható a stabilitása.

NL BELANGRIJK!

Het is belangrijk om elk product dat met om het even welk soort schroef wordt gemonteerd, twee weken na montage en om de drie maanden, opnieuw wordt vastgeschroefd, om de stabiliteit van het product tijdens de hele levensduur te verzekeren.

SK DŔLEŽITÉ!

Je dôležité, aby sa na akomkoľvek produkte, montovanom pomocou akýchkoľvek skrutiek, skrutky dotiahli po dvoch týždňoch od montáže, a jedenkrát v priebehu každých 3 mesiacov – tak sa zaručí stabilita počas celej životnosti produktu.

FR IMPORTANT

Il est important que tout produit monté à l'aide de vis soit resserré 2 semaines après son montage, puis tous les 3 mois, afin de garantir sa stabilité durant tout son cycle de vie.

SI POMEMBNO!

Vsak izdelek, ki ga sestavite z uporabo kakršnihkoli vijakov morate 2 tedna po sestavitvi ponovno pregledati in vijake po potrebi priviti. To ponovite vsake 3 mesece, da bi zagotovili stabilnost izdelka skozi njegovo celotno življenjsko dobo.

HR VAŽNO!

Važno je da se svi tipovi vijaka na bilo kojoj vrsti proizvoda koji se s pomá u njih sastavlja ponovno pritegnu 2 tjedna nakon sastavljanja te jednom svaka 3 mjeseca - kako bi se zajamčila stabilnost tijekom životnog vijeka proizvoda.

IT IMPORTANTE!

È importante in ogni prodotto montato con viti serrare ben strette le viti 2 settimane dopo il montaggio e poi ogni 3 mesi per garantire la sua stabilità durante tutta la durata del prodotto.

ES IMPORTANTE

En el caso de los productos ensamblados, es importante volver a apretar los tornillos 2 semanas después del montaje y después cada 3 meses, para así preservar la estabilidad durante toda la vida útil del producto.

BA VAŽNO!

Za sve proizvode sa vijčanim vezama, potrebno je izvršiti pritezanje 2 sedmice nakon sklapanja i svaka 3 mjeseca nakon toga, kako bi se osigurala stabilnost tokom cijelog životnog vijeka proizvoda.

RS VAŽNO!

Važno je da svaki proizvod koji je sklopljen korišćenjem bilo kakvih šrafova bude ponovo pričvršćen 2 nedelje nakon sklapanja i jednom svaka 3 meseca - kako bi se obezbedila stabilnost tokom celog veka trajanja proizvoda.

UA УВАГА.

Майте на увазі, якщо у процесі монтажу продукту використовуються гвинти будь-якого типу, їх треба повторно затягнути через 2 тижні після монтажу, а потім кожні 3 місяці. Це необхідно для того, щоб забезпечити надійне використання продукту протягом терміну його служби.

RO IMPORTANT!

Este important ca șuruburile de orice tip, cu ajutorul cărora au fost montate produsele, să fie strânse din nou la 2 săptămâni după montare și, apoi, o dată la 3 luni, pentru a se asigura stabilitatea de-a lungul duratei de viață a produsului

BG ВАЖНО!

Важно е всеки продукт, който е сглобен с помощта на винтове, да бъде затегнат 2 седмици след сглобяването, и веднъж на всеки 3 месеца, за да се гарантира стабилност през цялото време на използване на продукта.

GR ΣΗΜΑΝΤΙΚΟ!

Για κάθε προϊόν που συναρμολογείται με βίδες είναι σημαντικό αυτές να ξανασφίγγονται 2 εβδομάδες μετά τη συναρμολόγηση και μία φορά κάθε 3 μήνες, για τη διασφάλιση της σταθερότητας σε όλη τη διάρκεια ζωής του προϊόντος.

PT AVISO IMPORTANTE!

È importante, em cada produto montado com parafusos, reapertar os mesmos 2 semanas após a montagem e uma vez a cada 3 meses para garantir a estabilidade do produto ao longo de toda a sua vida útil.

RU ВАЖНО!

В любом изделии, собранном с использованием винтов любого типа, необходимо через 2 недели после сборки и в дальнейшем каждые 3 месяца подтягивать винты, чтобы обеспечить прочность изделия в течение срока эксплуатации.

TR ÖNEMLİ!

Vida kullanılarak yapılan her türlü ürün montajı için montajdan 2 hafta sonra vidaların yeniden sıkıştırılması ve kullanım süresi boyunca ürün istikrarının sağlanması için de her 3 ayda bir vidaların sıkıştırılması önem arz eder.



CN 重要提示!

使用任何类型的螺钉组装的产品，必须在组装 2 周后重新拧紧，并且每 3 个月重新拧紧一次，以确保产品在整个使用期内结实稳固。

من المهم إعادة إحكام ربط أي منتج تم تجميعه باستخدام أي نوع من البراغي بعد أسبوعين من التجميع، ومرة واحدة كل 3 أشهر - لضمان الثبات طوال عمر المنتج

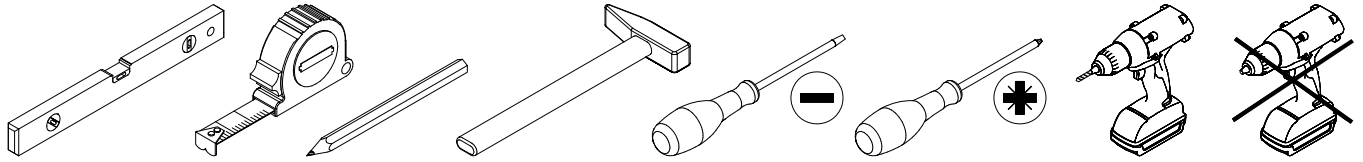
مهم AR

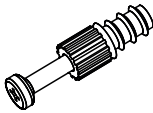
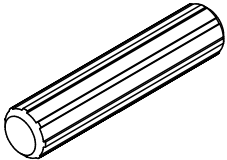
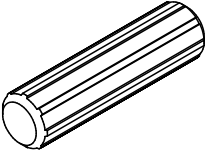
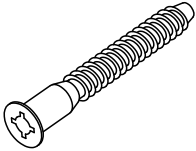
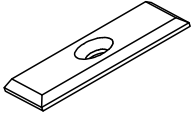
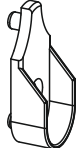
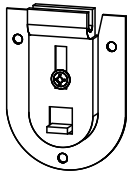
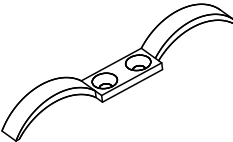
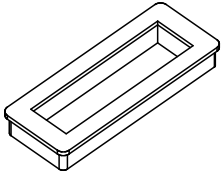
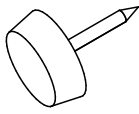
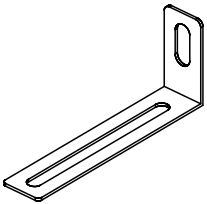
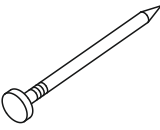
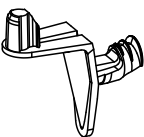
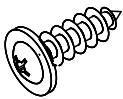

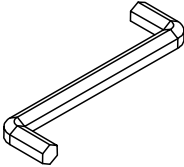
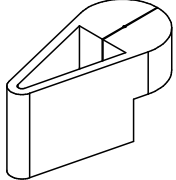
<p>A x 8</p>  <p>Ø7x44 mm</p>	<p>B x 20</p>  <p>Ø15x12 mm</p>	<p>C x 12</p>  <p>Ø7x31 mm</p>	<p>D x 4</p>  <p>Ø8x60 mm</p>
<p>E x 34</p>  <p>Ø8x35 mm</p>	<p>F x 16</p>  <p>Ø6,3x50 mm</p>	<p>G x 24</p>  <p>22x10x2 mm</p>	<p>H x 4</p>  <p>42x17x19 mm</p>
<p>J x 6</p>  <p>71x52x13 mm</p>	<p>K x 6</p>  <p>78x44x14 mm</p>	<p>L x 3</p>  <p>66x8x7 mm</p>	<p>M x 3</p>  <p>108x42x15 mm</p>
<p>N x 8</p>  <p>Ø15 mm</p>	<p>P x 2</p>  <p>75x32x15 mm</p>	<p>Q x 110</p>  <p>Ø1,5x20 mm</p>	<p>R x 12</p>  <p>20x19x11 mm</p>
<p>S x 4</p>  <p>Ø4x16 mm</p>	<p>T x 24</p>  <p>Ø8 mm</p>	<p>U x 1</p>  <p>4 mm</p>	<p>V x 1</p>  <p>19x40 mm</p>

W x 22

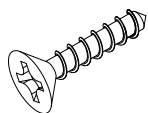

Ø3,5x16 mm

Y x 12



Ø6,3x13 mm

Z x 12



Ø14 mm

AA x 8



Ø3x20 mm

AB x 4

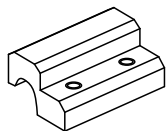

30x17x13 mm

AC x 6



M4x9 mm

AD x 22



Ø3,5x13 mm

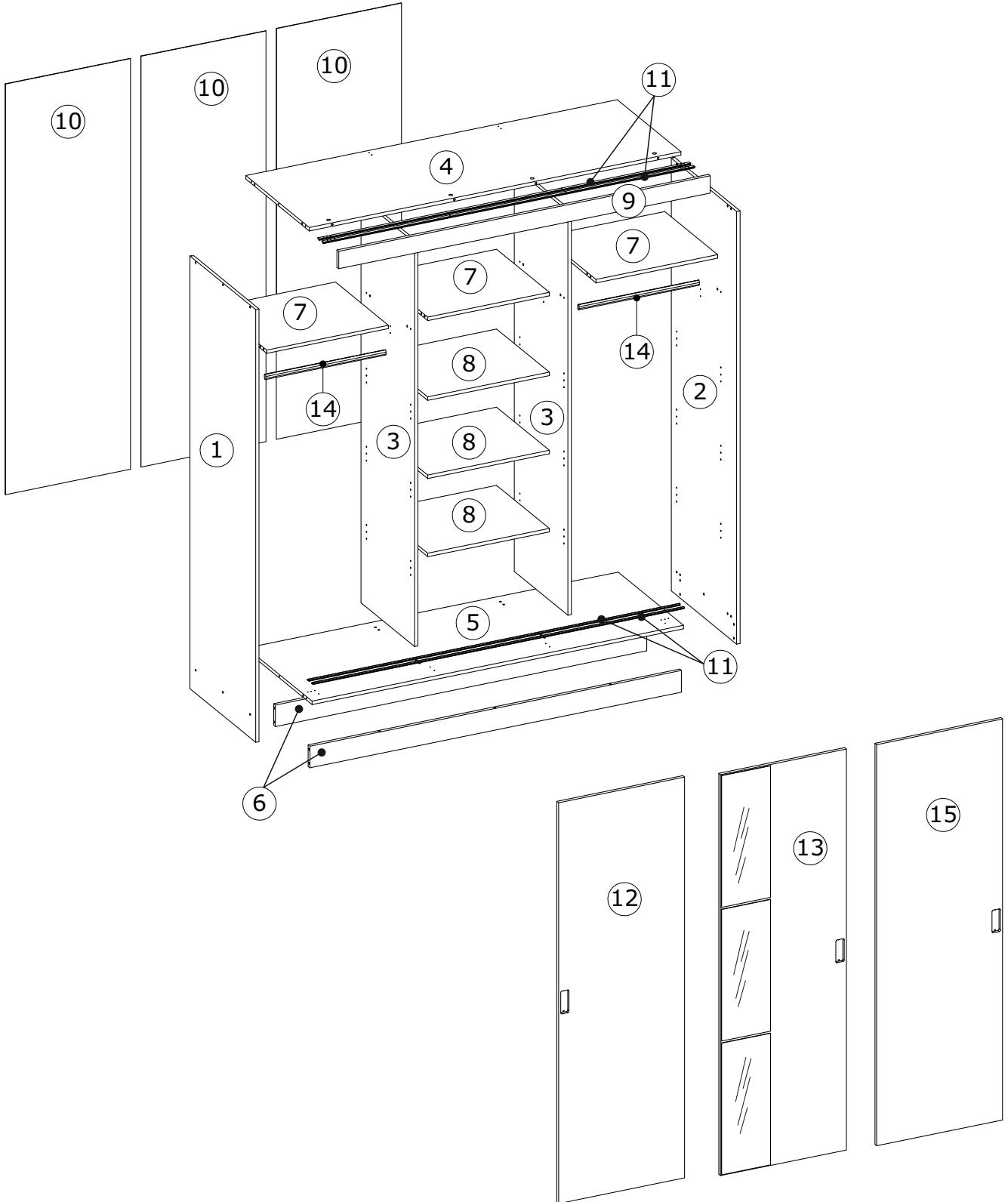
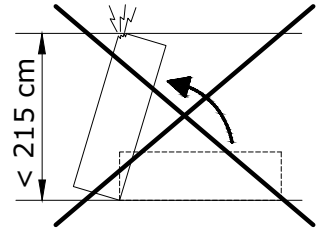
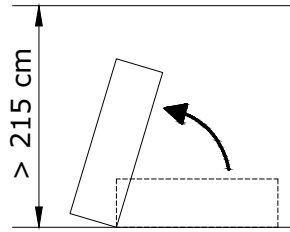
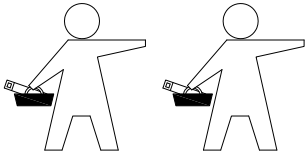

BOX 1/6:

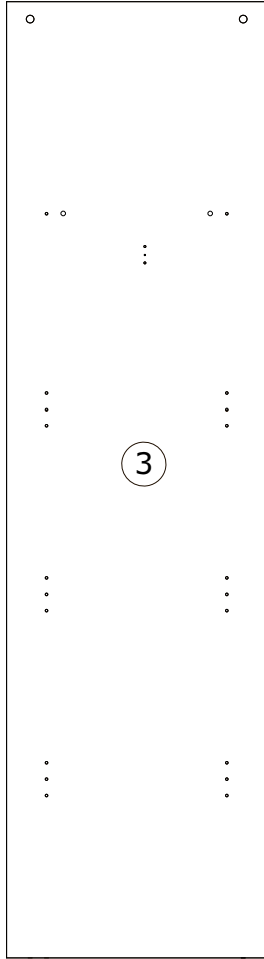

1867x505x16 mm

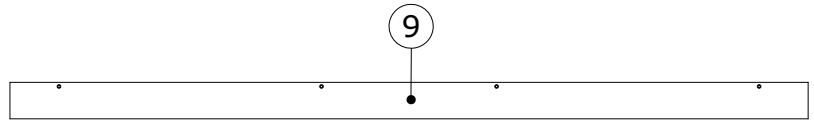

1751x80x16 mm

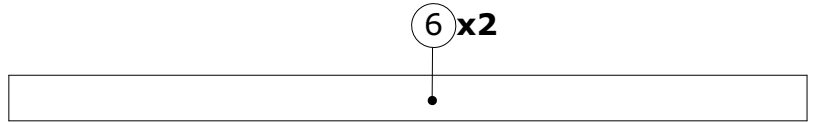

1751x100x16 mm

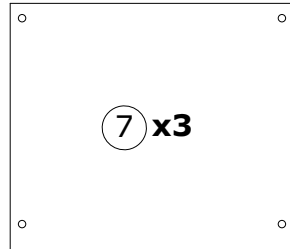

573x498x16 mm

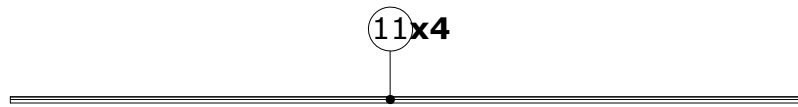

1750 mm

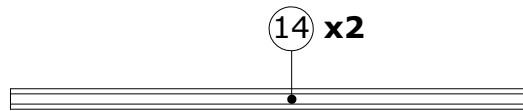

566x20x15 mm

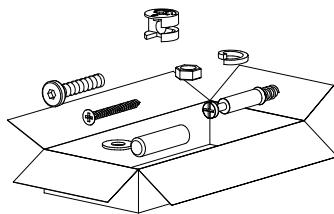

BOX 2/6:

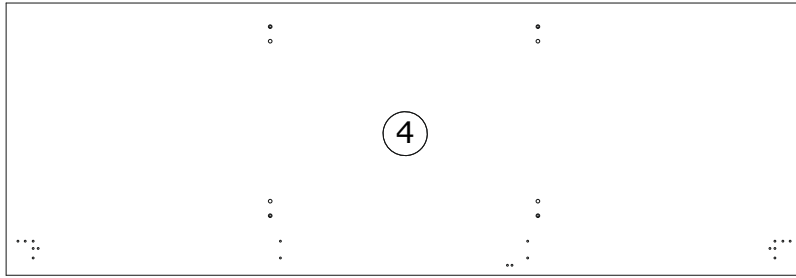

1751x600x16 mm

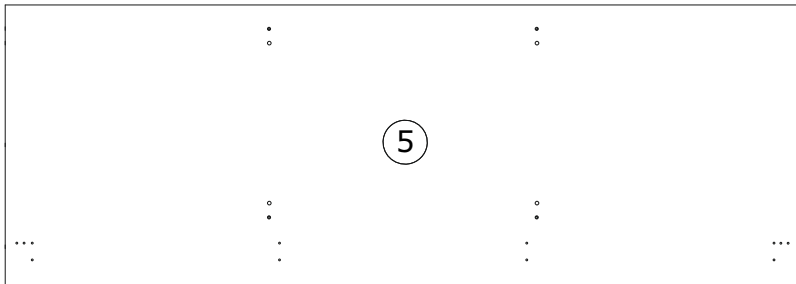

1751x616x16 mm

BOX 3/6:

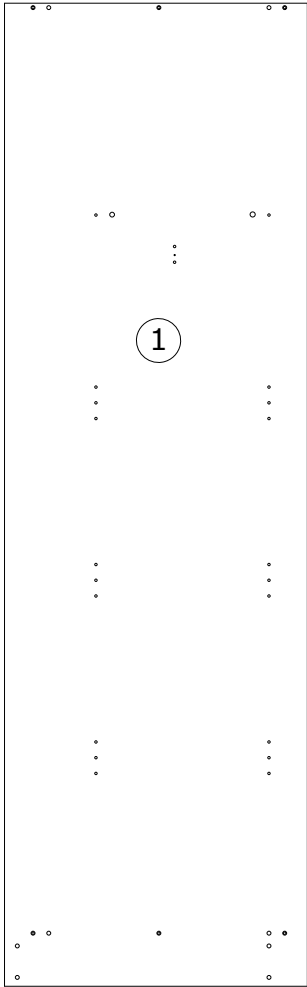

2000x620x16 mm

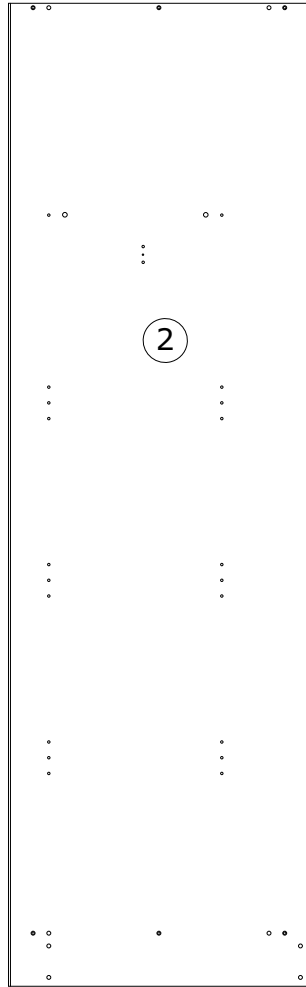

2000x620x16 mm

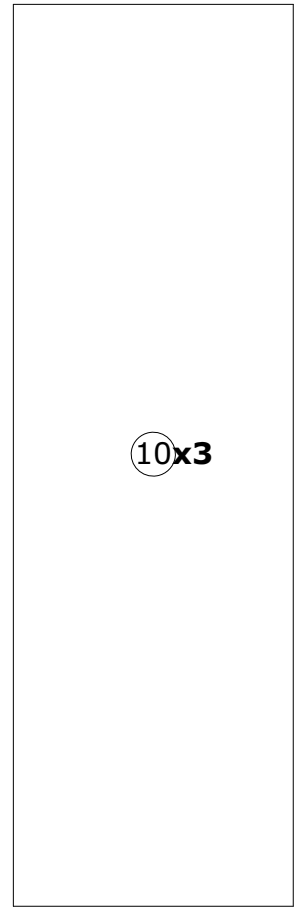

1898x589x2,5 mm

BOX 4/6:

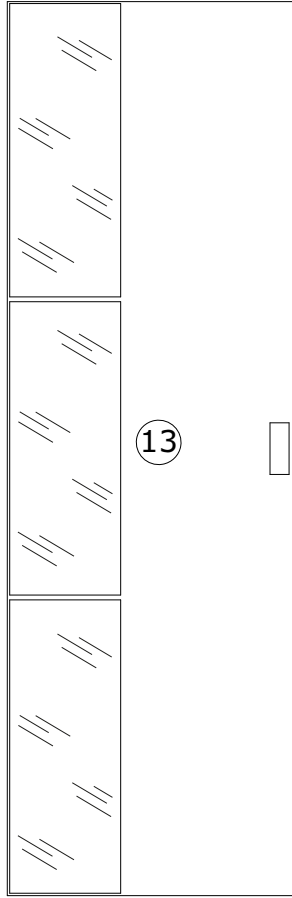

1853x594x19 mm

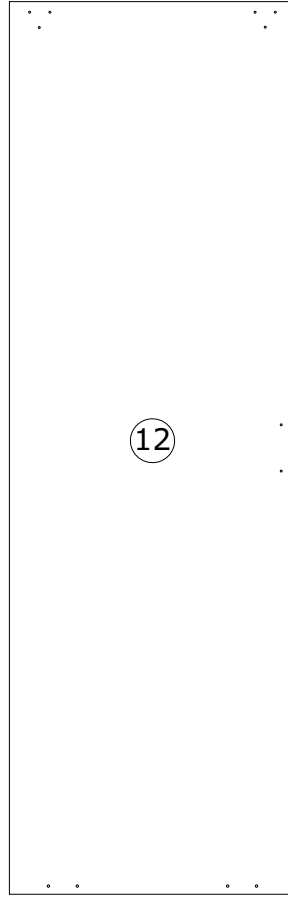

1853x594x16 mm

BOX 5/6:

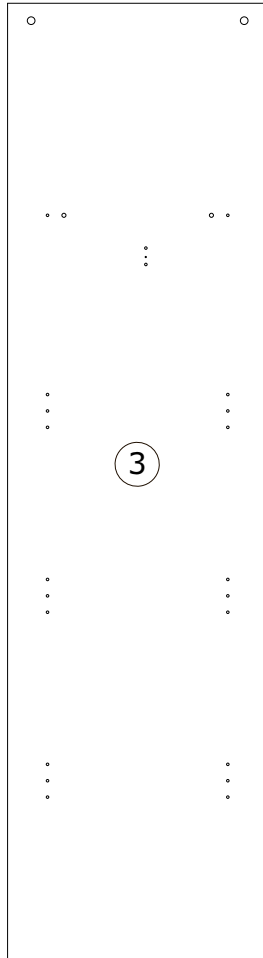

1867x505x16 mm

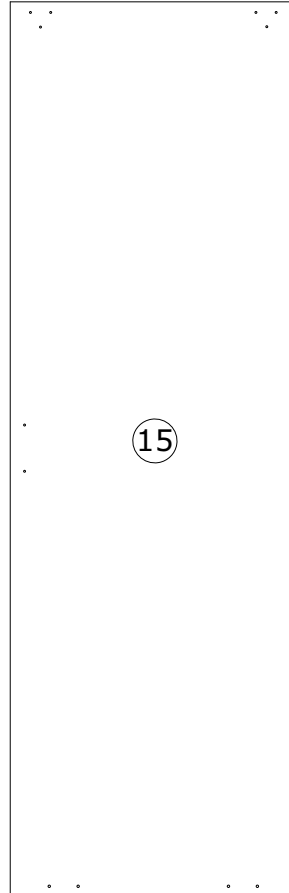

1853x594x16 mm



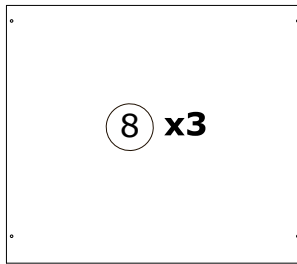

BOX 6/6:





573x498x16 mm

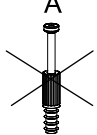

1

E x 4  Ø8x35 mm	C x 2  Ø7x31 mm	 
--	--	---

			
---	---	---	---

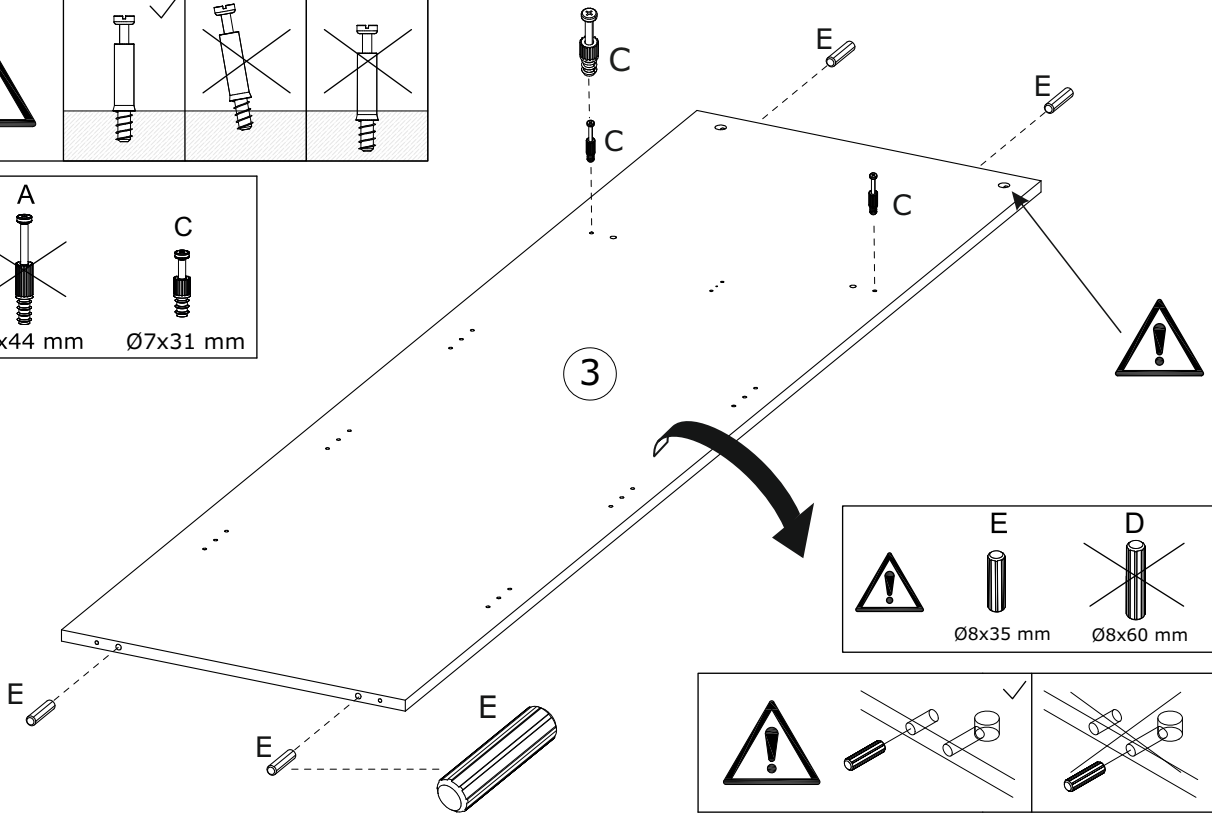



		
	Ø7x44 mm	Ø7x31 mm

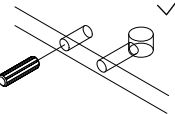
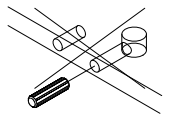





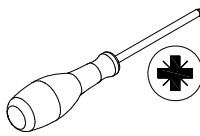



	E  Ø8x35 mm	D  Ø8x60 mm
---	--	---

		
--	--	--

2

C x 2  Ø7x31 mm	H x 1  42x17x19 mm	W x 1  Ø3,5x16 mm	 
--	---	--	---

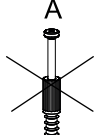

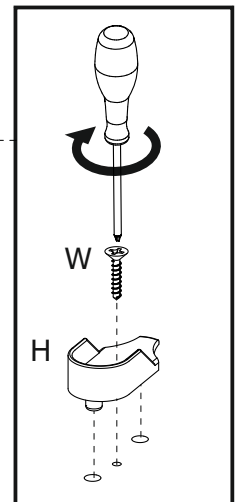
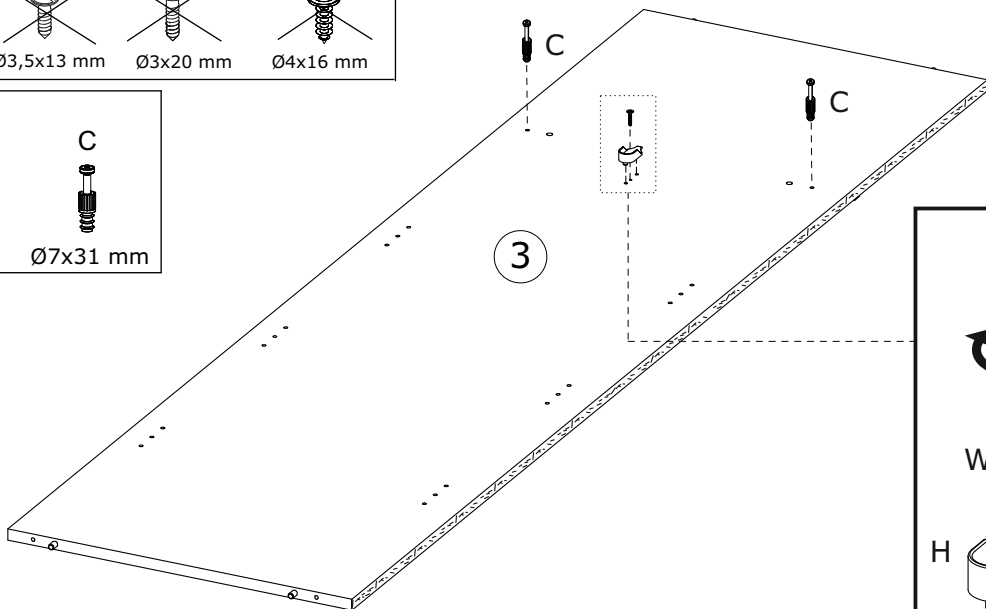

	W  Ø3,5x16 mm	AD  Ø3,5x13 mm	AA  Ø3x20 mm	S  Ø4x16 mm
---	---	--	--	---



		
	Ø7x44 mm	Ø7x31 mm



3

C x 2  Ø7x31 mm	H x 1  42x17x19 mm	W x 1  Ø3,5x16 mm	
--	---	--	---



 W  Ø3,5x16 mm	AD  Ø3,5x13 mm	AA  Ø3x20 mm	S  Ø4x16 mm
--	---	---	--

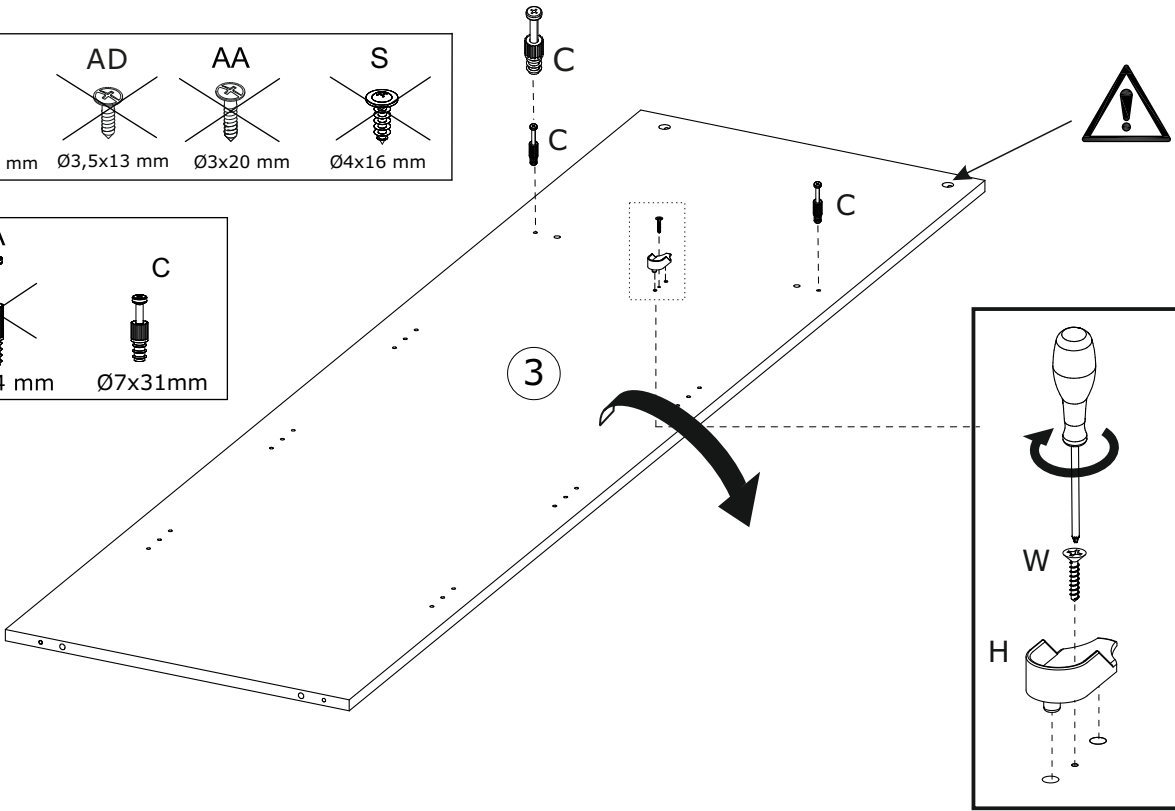

 A  Ø7x44 mm	C  Ø7x31mm
---	---



4

C x 2  Ø7x31 mm	E x 4  Ø8x35 mm		
--	--	---	---

 A  Ø7x44 mm	C  Ø7x31mm
---	---

 E  Ø8x35 mm	D  Ø8x60 mm
--	--

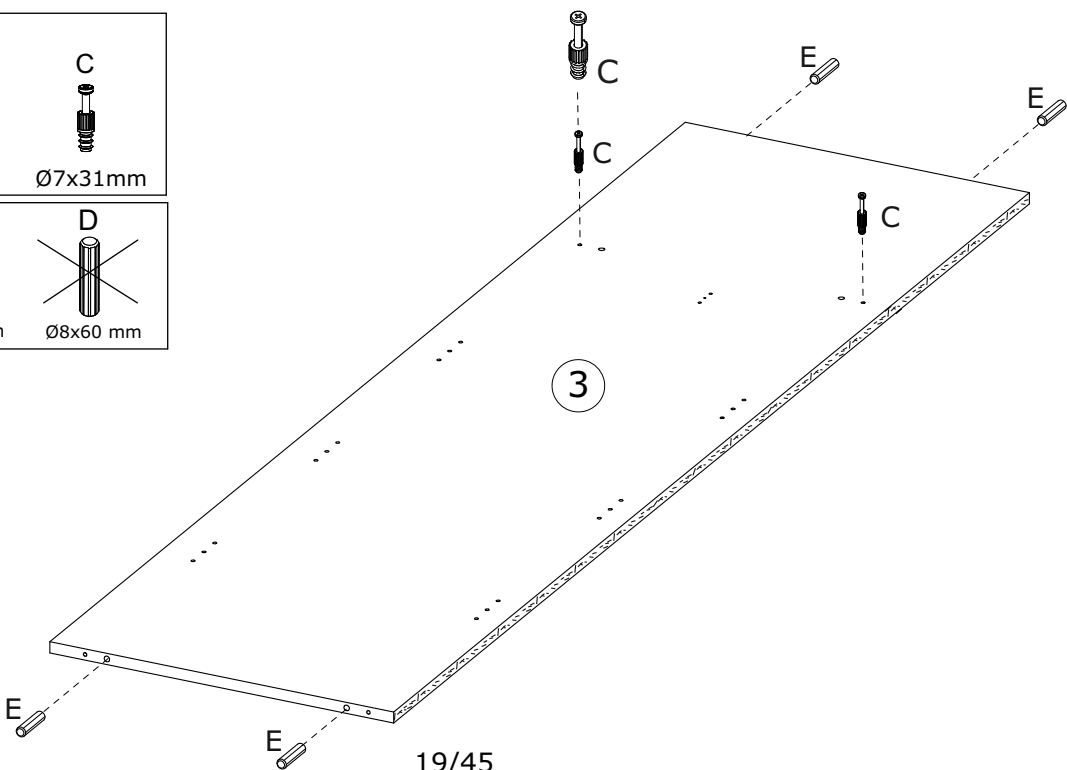

5

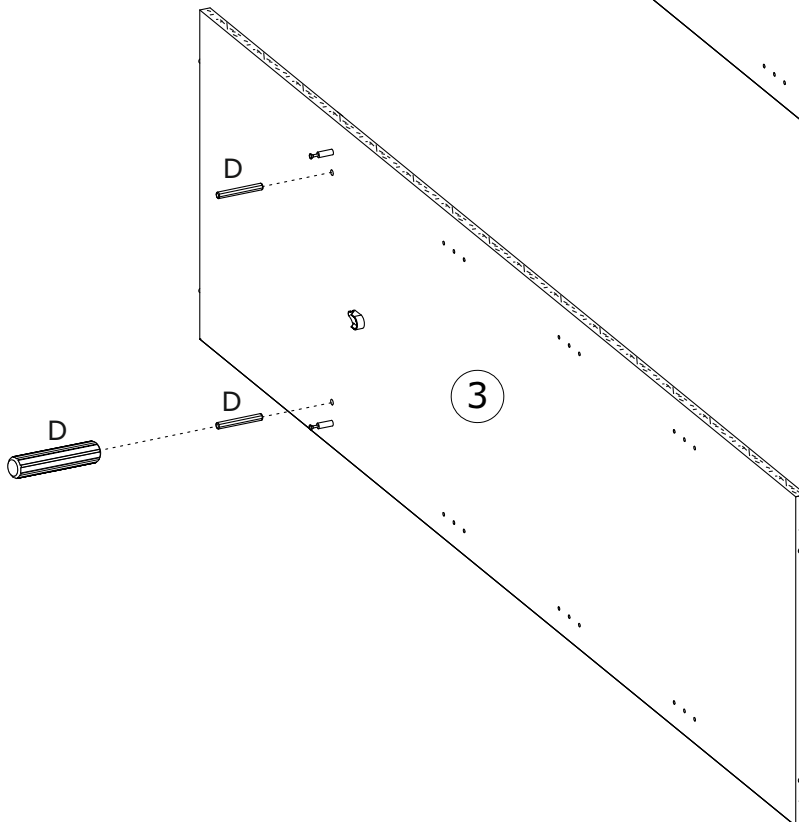
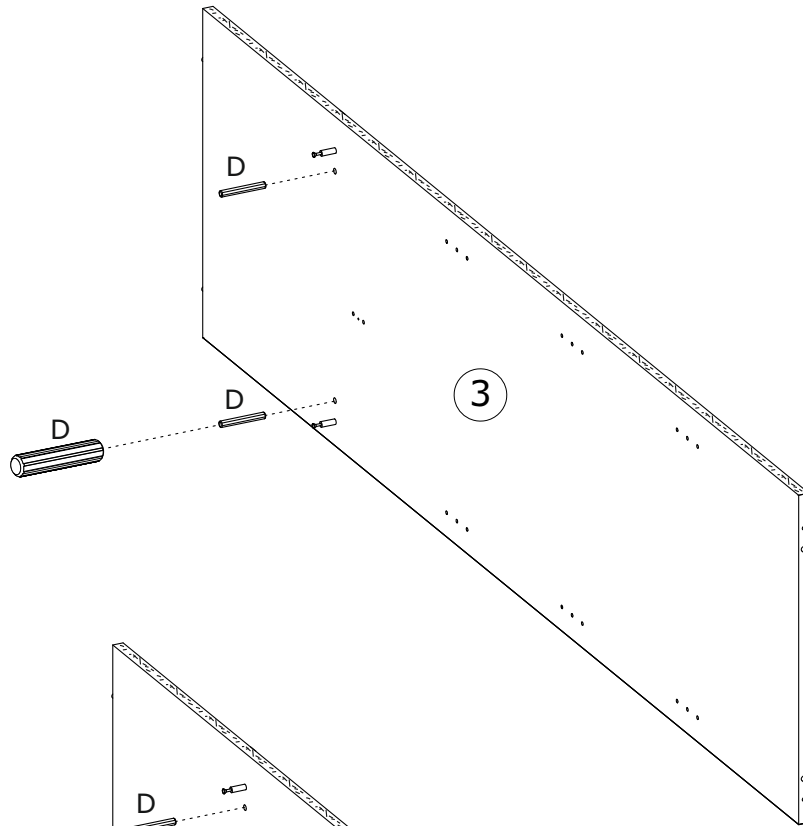
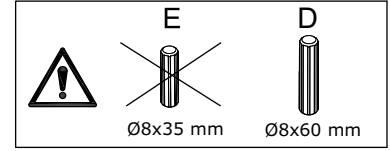
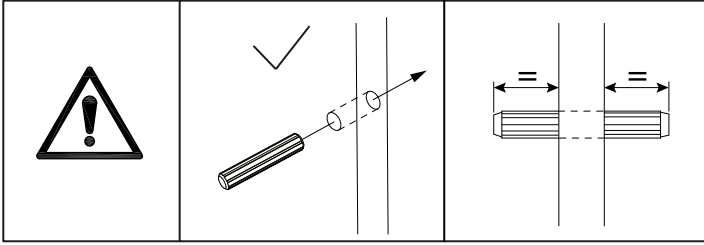
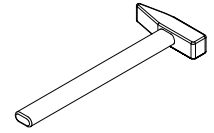
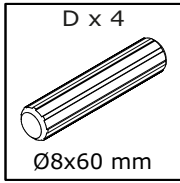

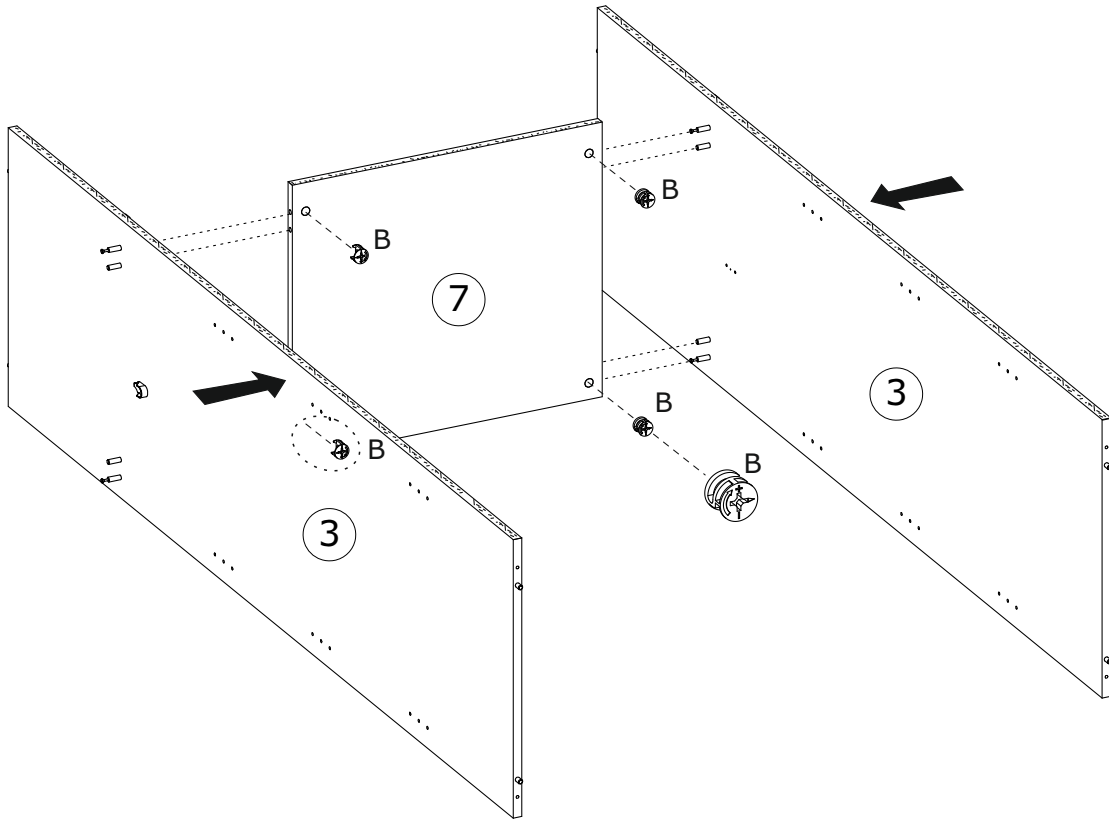
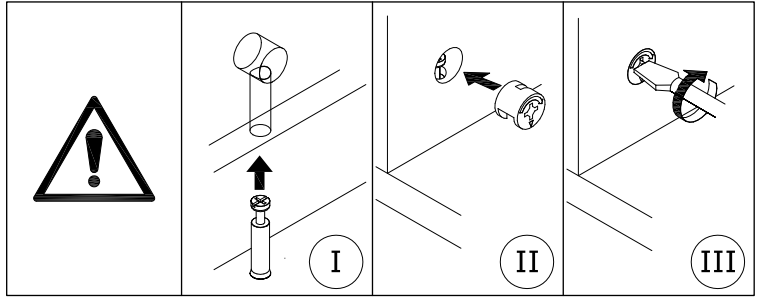
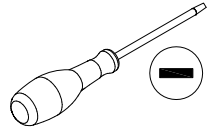

6

B x 4
Ø15x12 mm



7



A x 4  Ø7x44 mm	AD x 8  Ø3,5x13 mm		
--	---	---	---

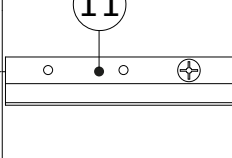

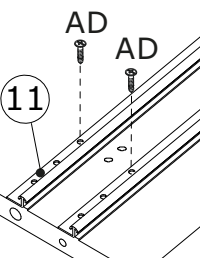

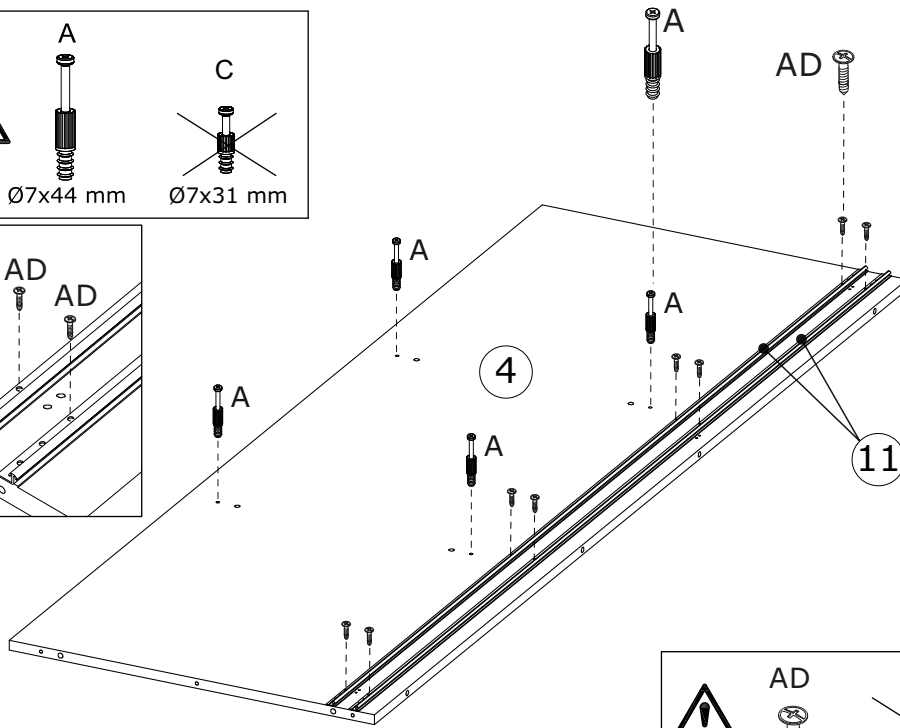
	A  Ø7x44 mm	C  Ø7x31 mm
---	--	--

	11  1mm
---	--

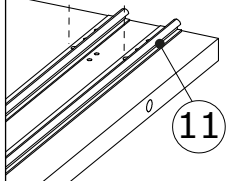
11 









AD 	AD 	11 
---	---	---

	AD  Ø3,5x13 mm	W  Ø3,5x16 mm	AA  Ø3x20 mm	S  Ø4x16 mm
--	---	--	---	--



8

L x 3  66x8x7 mm	AD x 6  Ø3,5x13 mm	
---	---	---

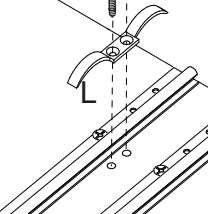
	AD  Ø3,5x13 mm	W  Ø3,5x16 mm	AA  Ø3x20 mm	S  Ø4x16 mm
---	---	--	---	--

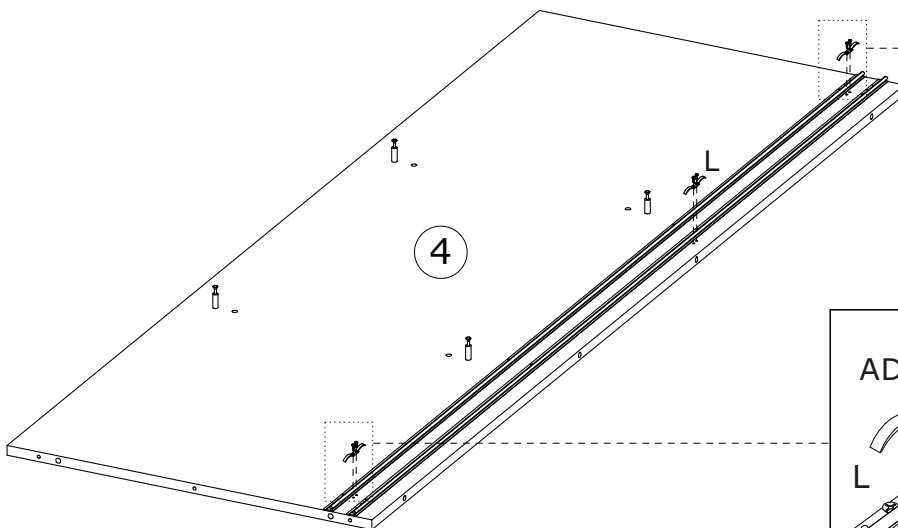

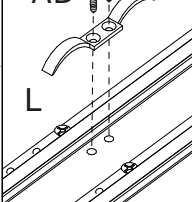

AD 	AD 	L 
---	---	--



AD 	AD 	L 
---	---	---



9



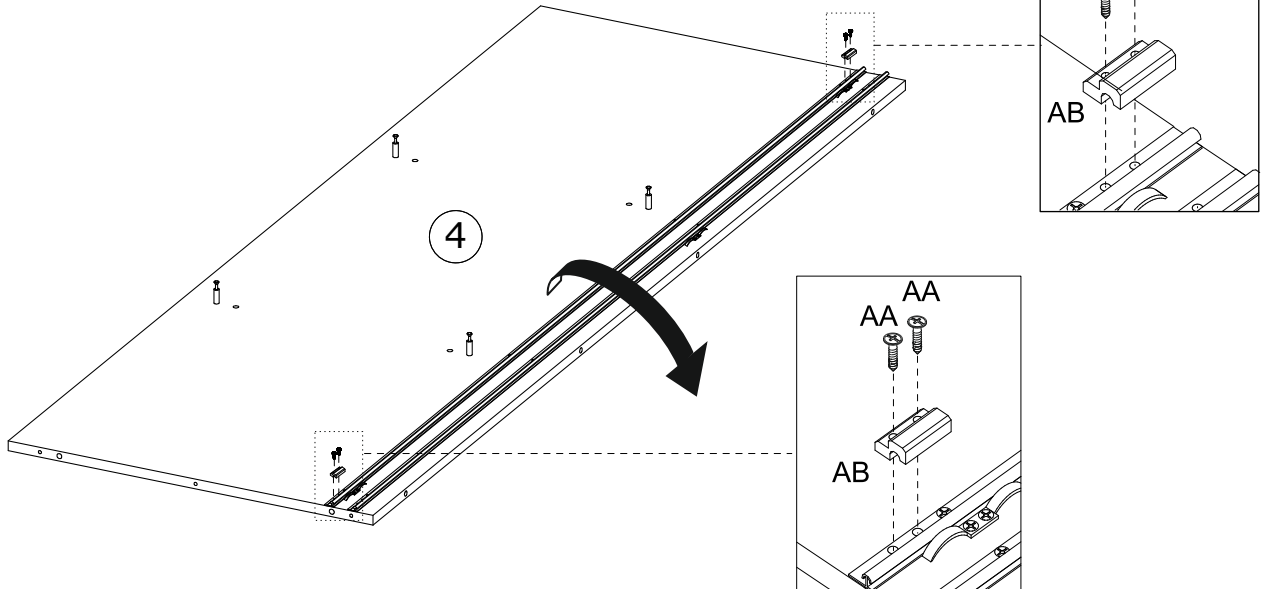

AA x 4  Ø3x20 mm	AB x 2  30x17x13 mm	 
---	--	---

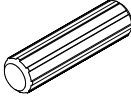
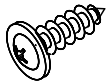
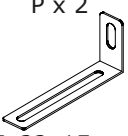
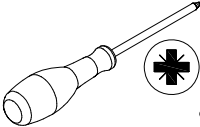
 AA  Ø3x20 mm	W  Ø3,5x16 mm	AD  Ø3,5x13	S  Ø4x16 mm
---	--	--	--

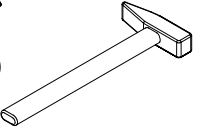

10

E x 4  Ø8x35 mm	S x 4  Ø4x16 mm	P x 2  75x32x15 mm	  
--	--	---	---

 S  Ø4x16 mm	W  Ø3,5x16 mm	AA  Ø3x20 mm	AD  Ø3,5x13
--	--	---	--

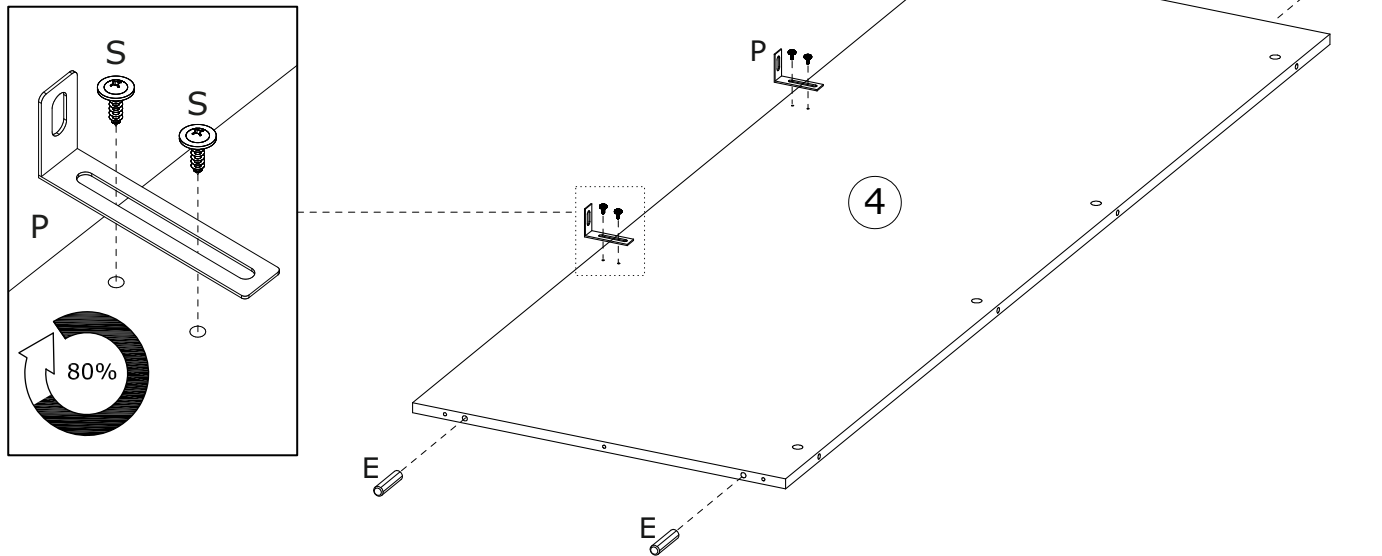

11

AD x 8
Ø3,5x13 mm

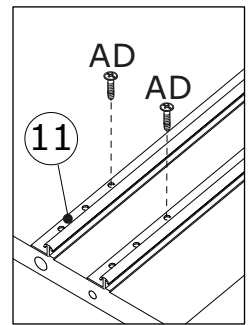
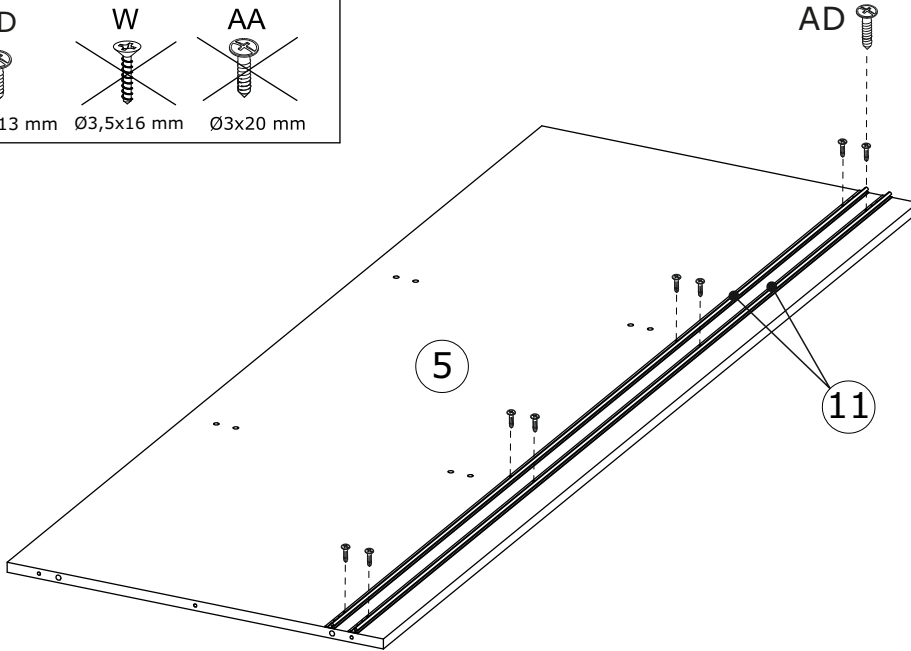
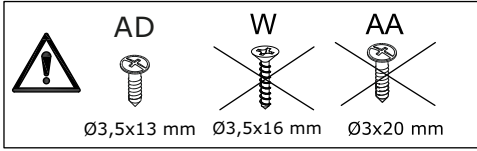
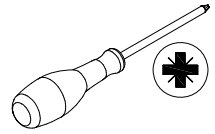

12

E x 4
Ø8x35 mm

AA x 4
Ø3x20 mm

AB x 2
30x17x13 mm

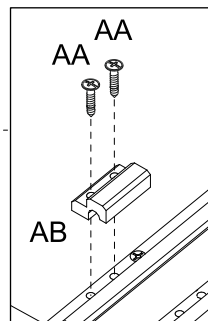
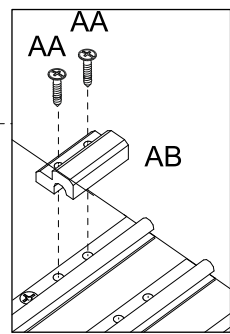
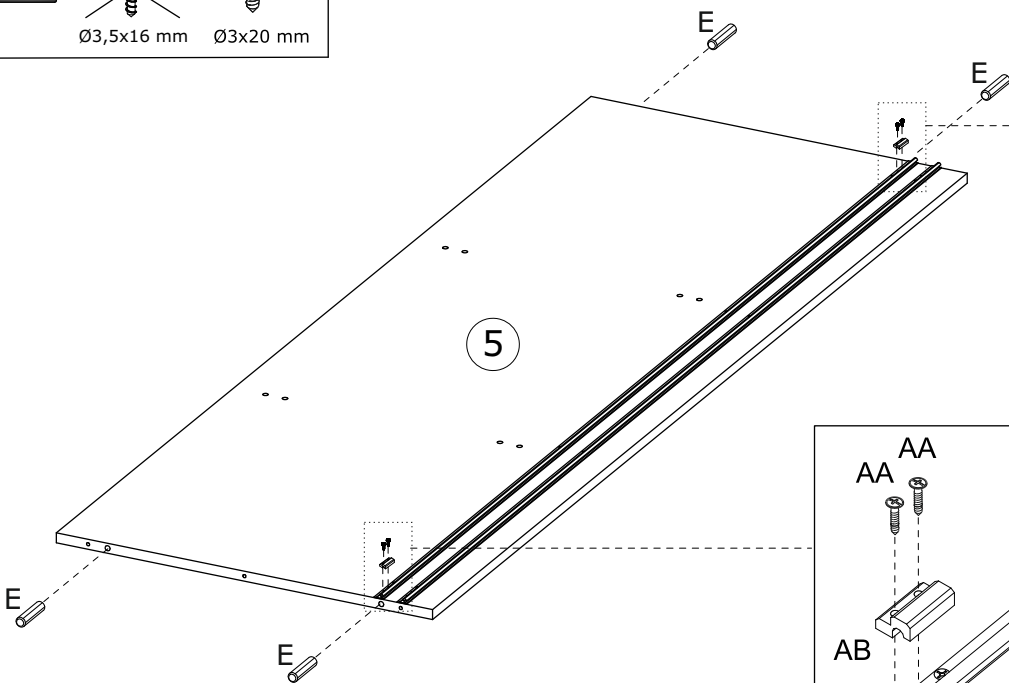
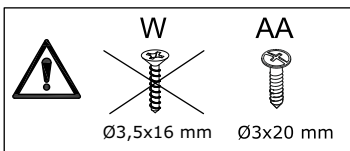
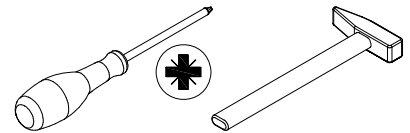

13

<p>B x 4</p>  <p>Ø15x12 mm</p>	<p>F x 4</p>  <p>Ø6,3x50 mm</p>	<p>U x 1</p>  <p>4 mm</p>	
---	--	--	---

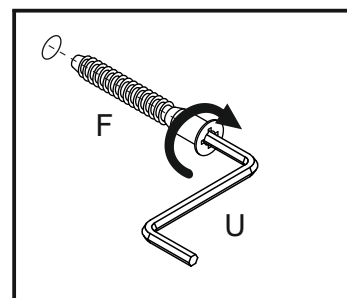
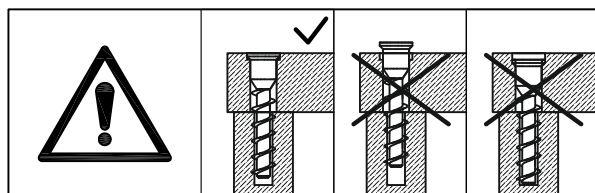
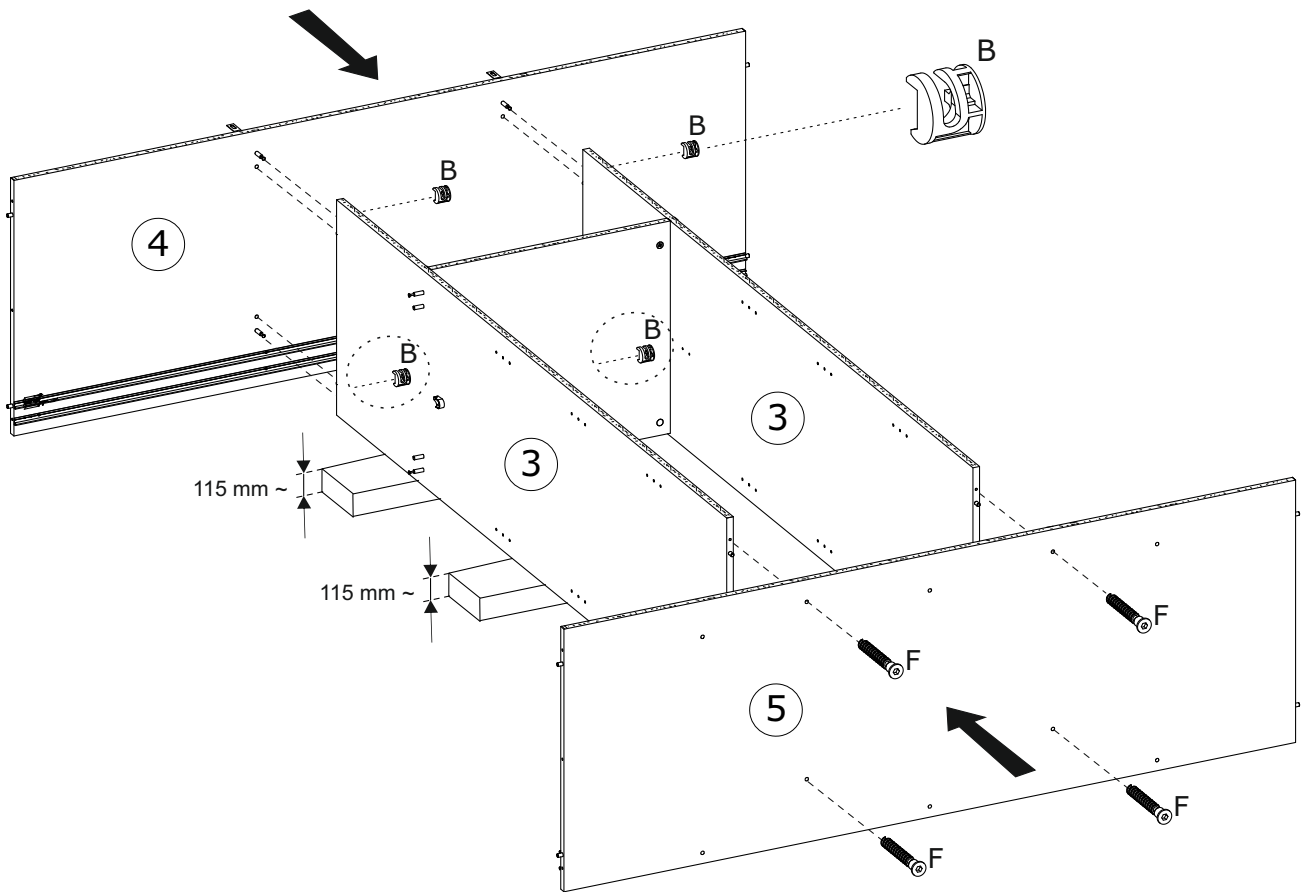
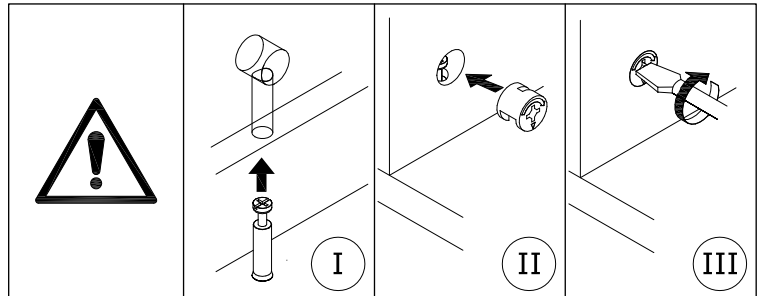

14



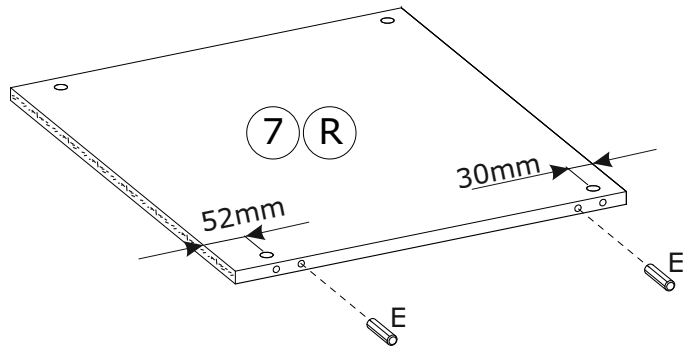
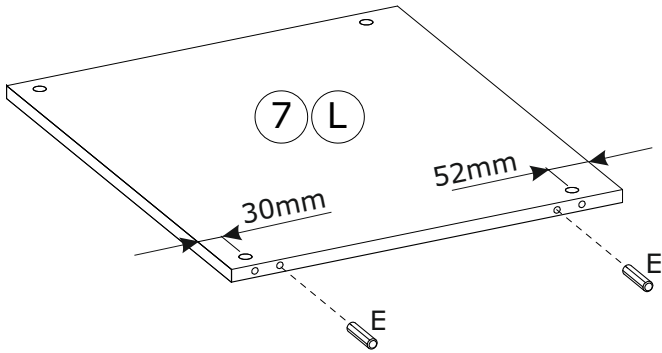
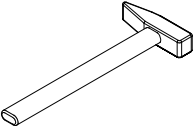

E x 4
Ø8x35 mm

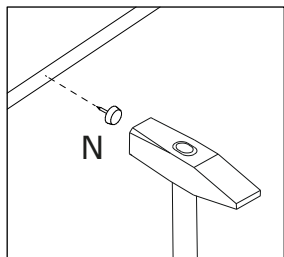
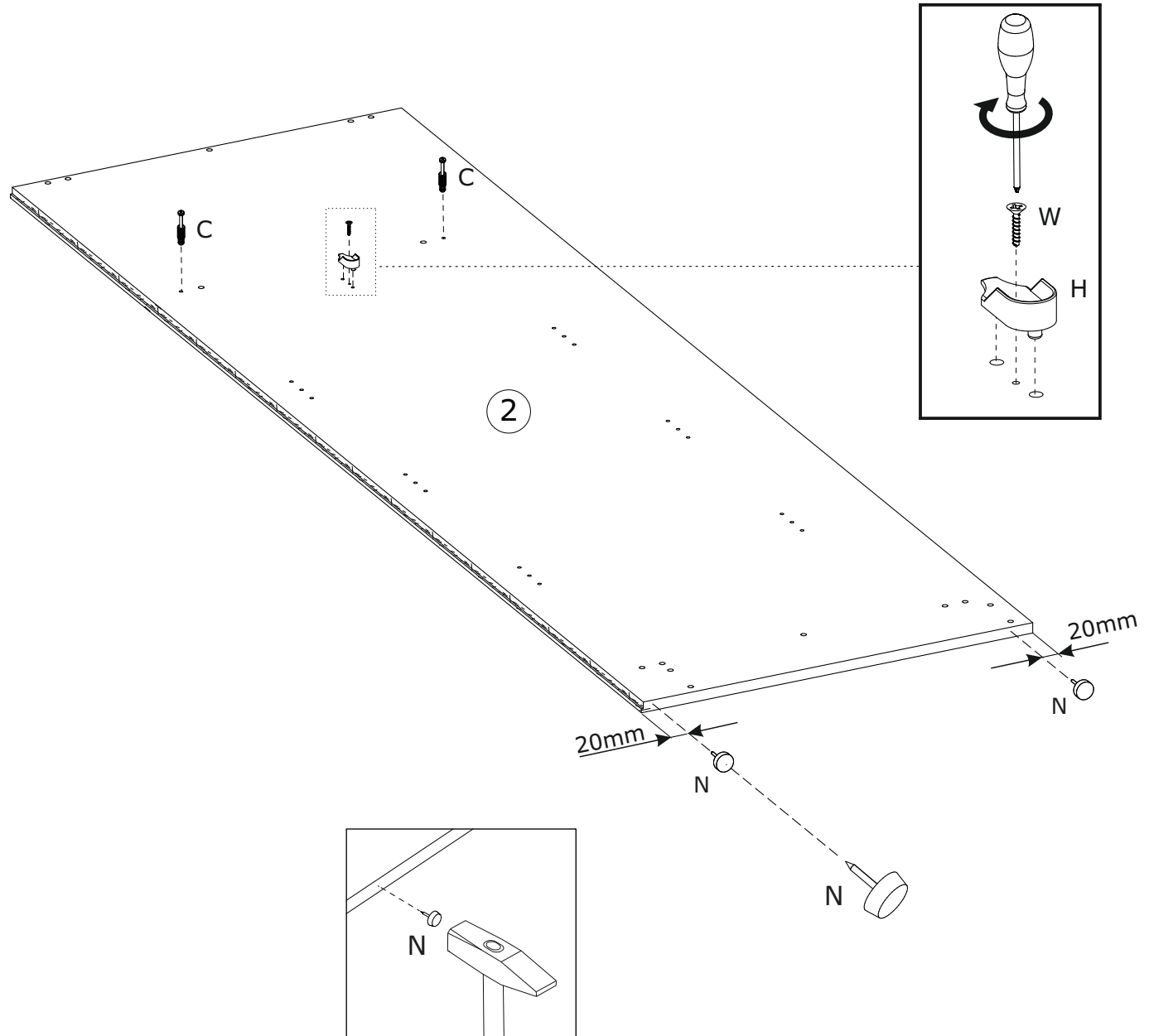
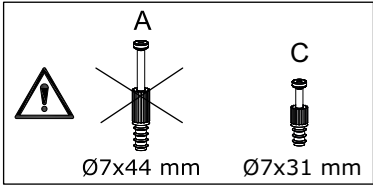
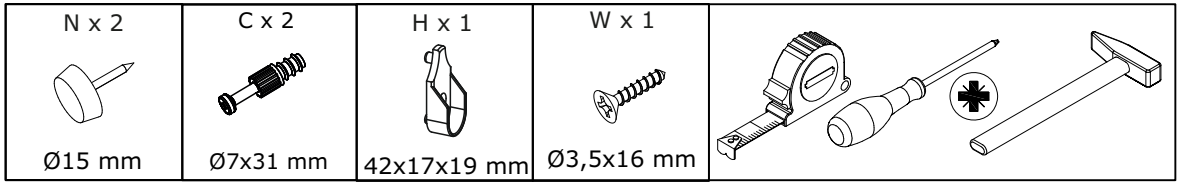

16

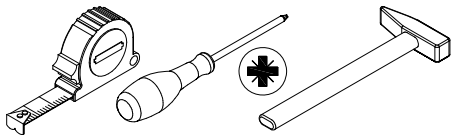

17

N x 2  Ø15 mm	C x 2  Ø7x31 mm	H x 1  42x17x19 mm	W x 1  Ø3,5x16 mm	
--	--	---	--	--

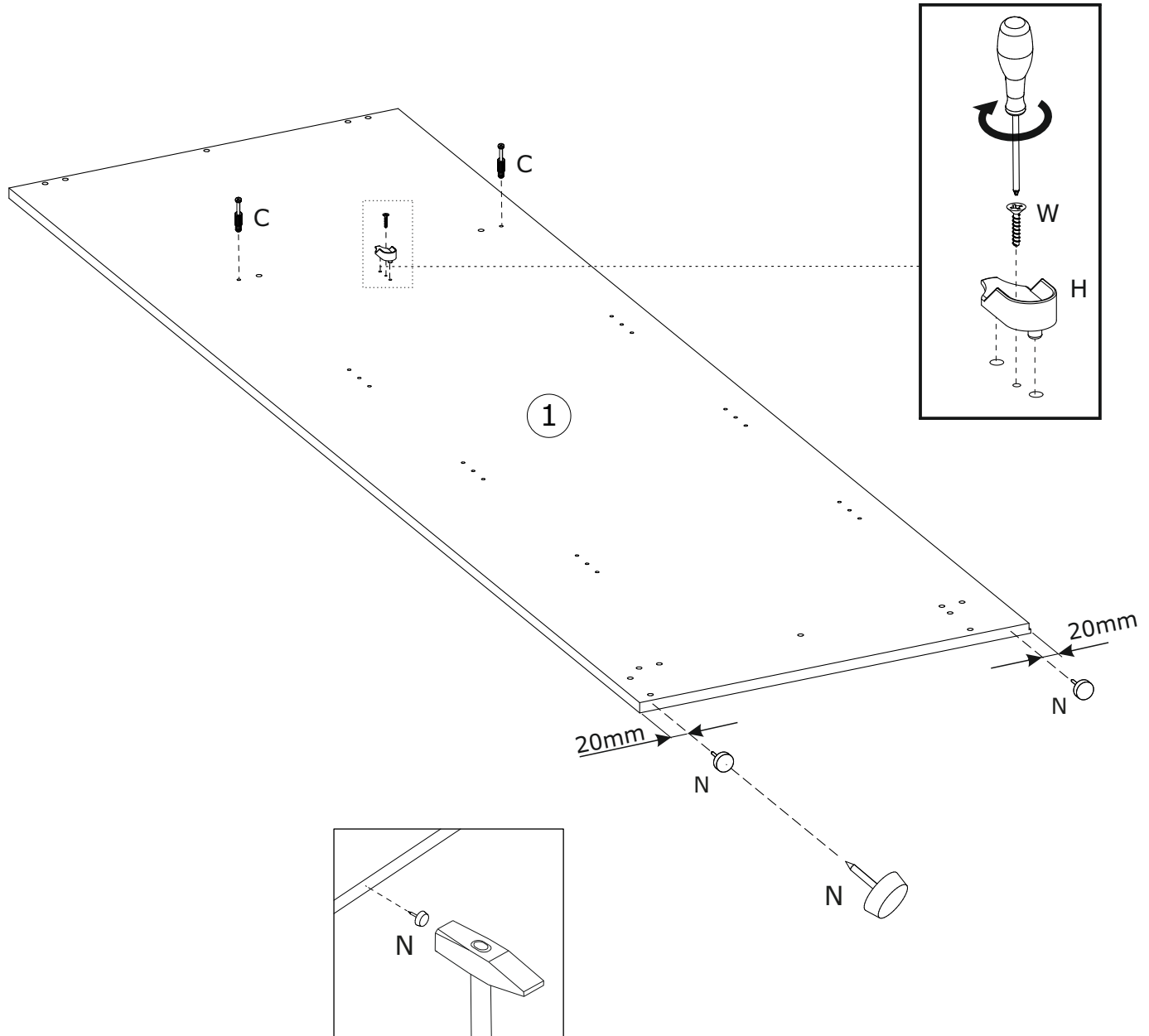
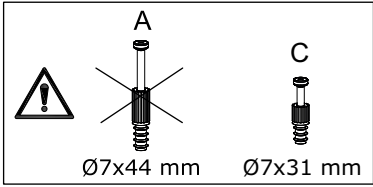

18

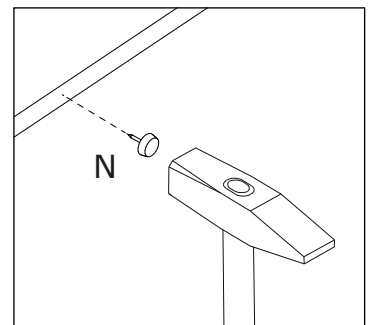
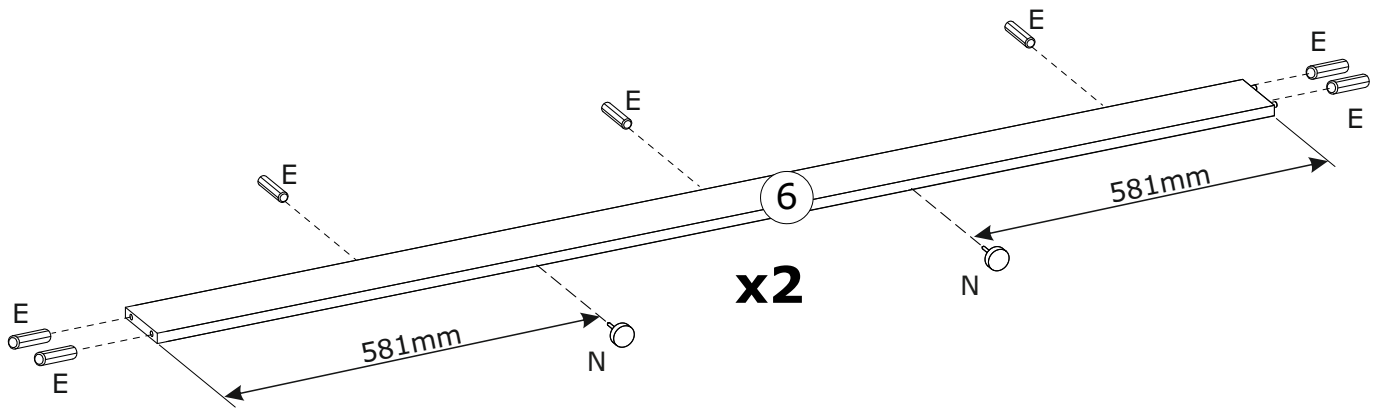

19

<p>B x 4</p>  <p>Ø15x12 mm</p>	<p>F x 12</p>  <p>Ø6,3x50 mm</p>	<p>U x 1</p>  <p>4 mm</p>	
---	---	--	---

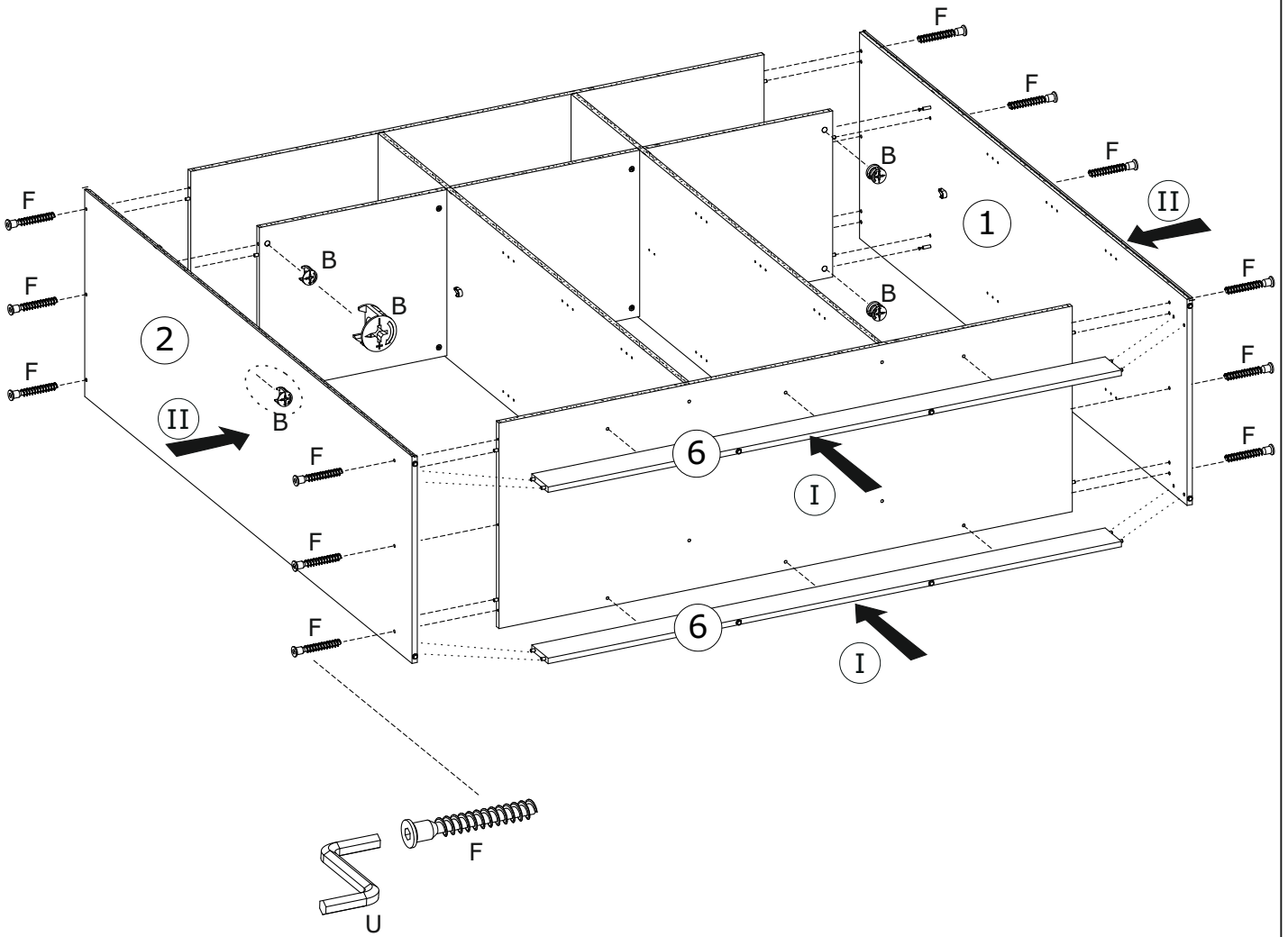

20

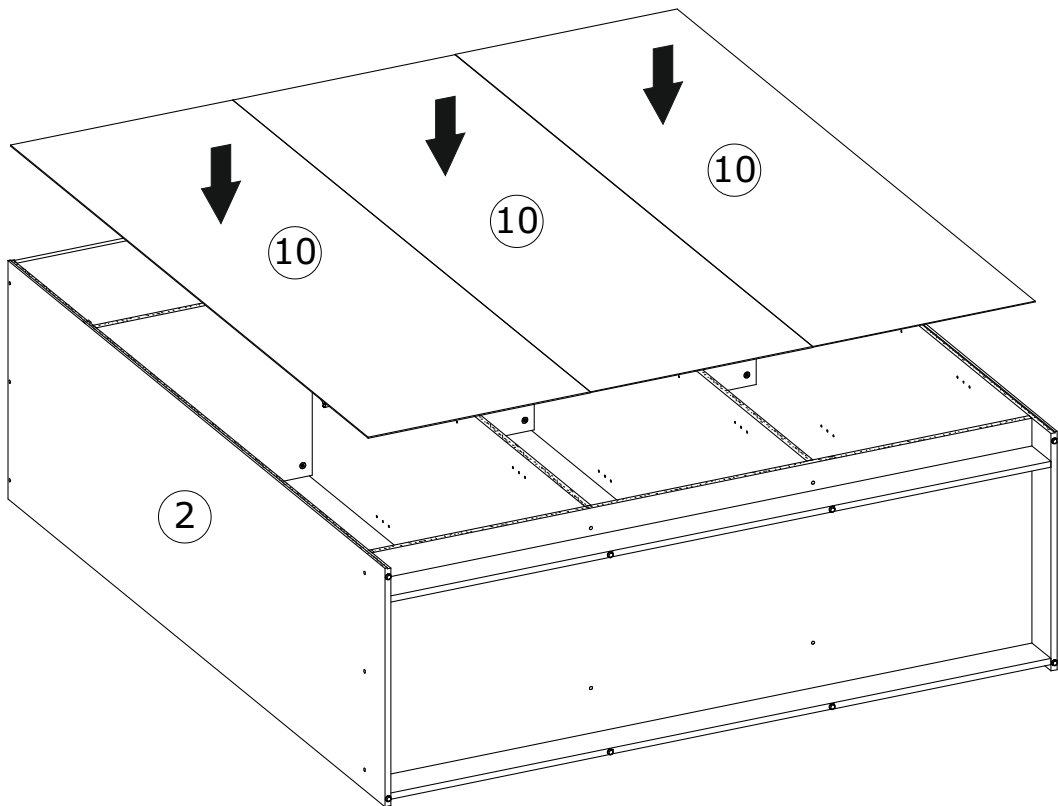

21

G x 24  22x10x2 mm	Q x 110  Ø1,5x20 mm	V x 1  19x40 mm	 
---	--	--	--



XX = YY ≅ 90°

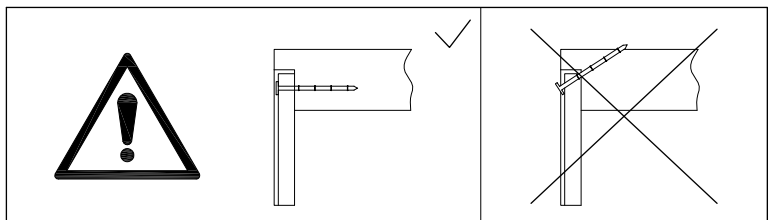
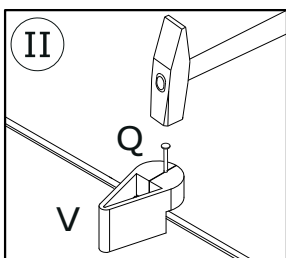
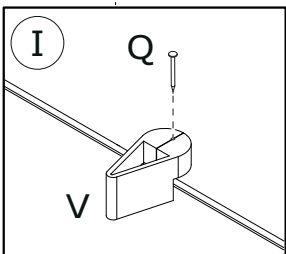
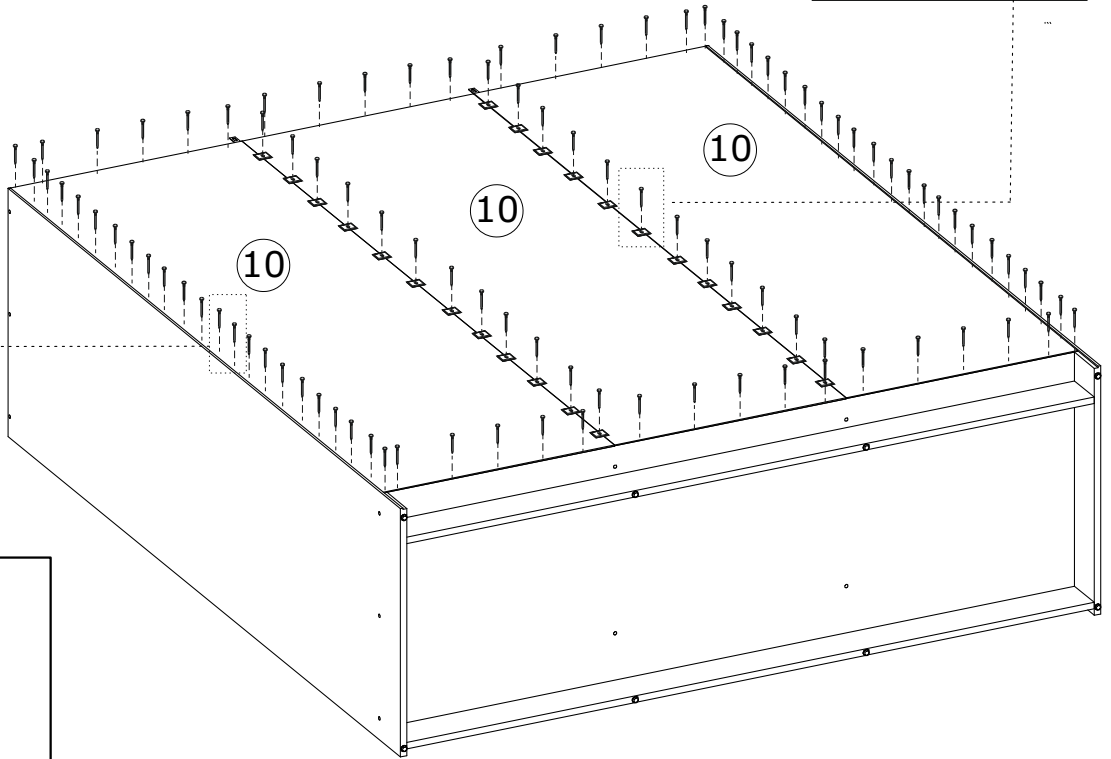
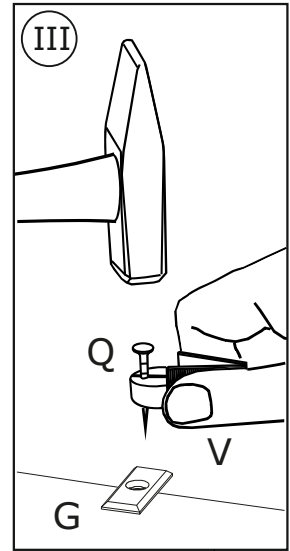
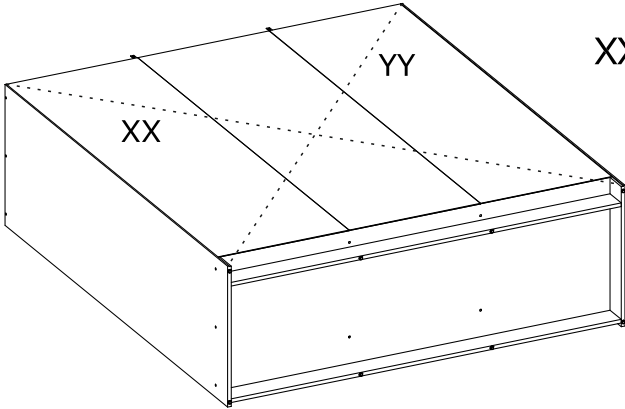

22

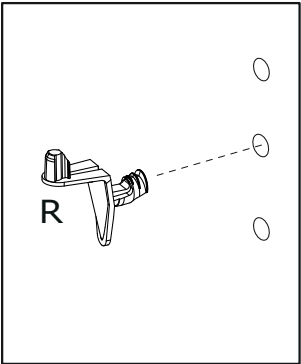
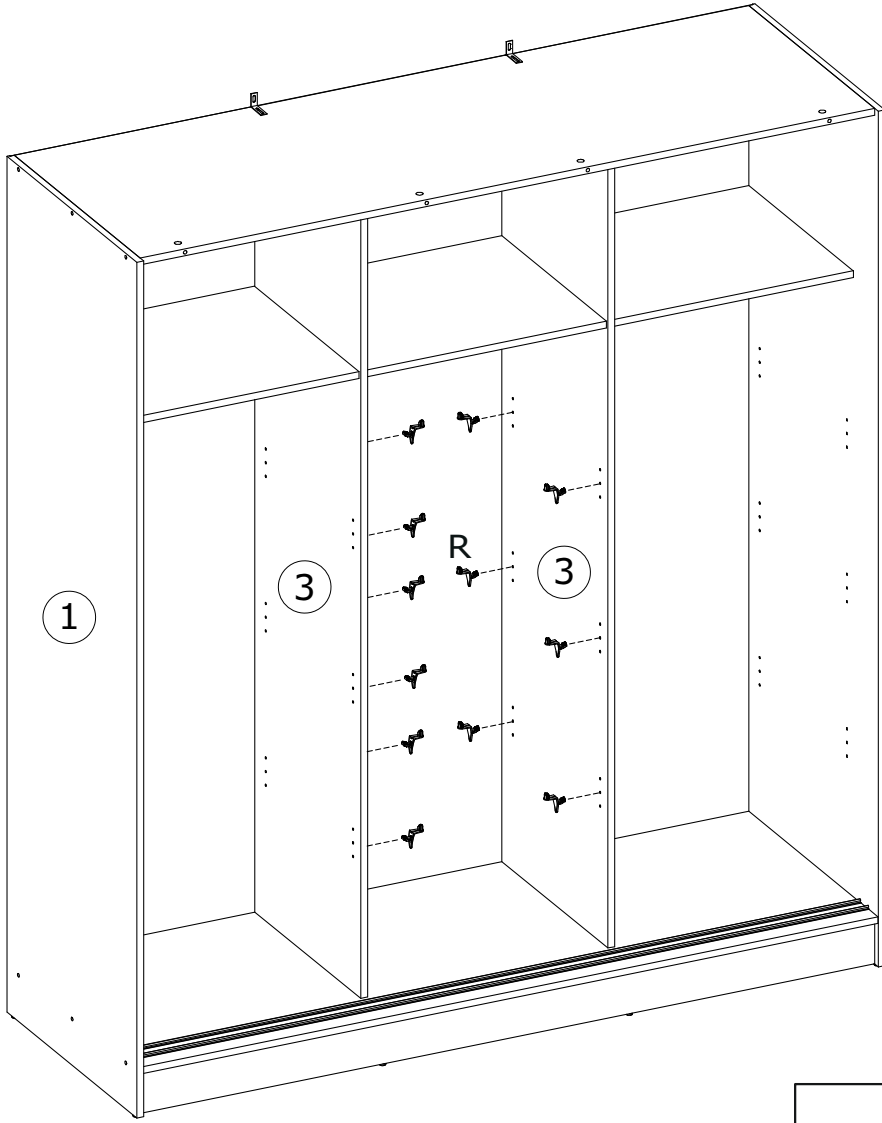

R x 12
20x19x11 mm

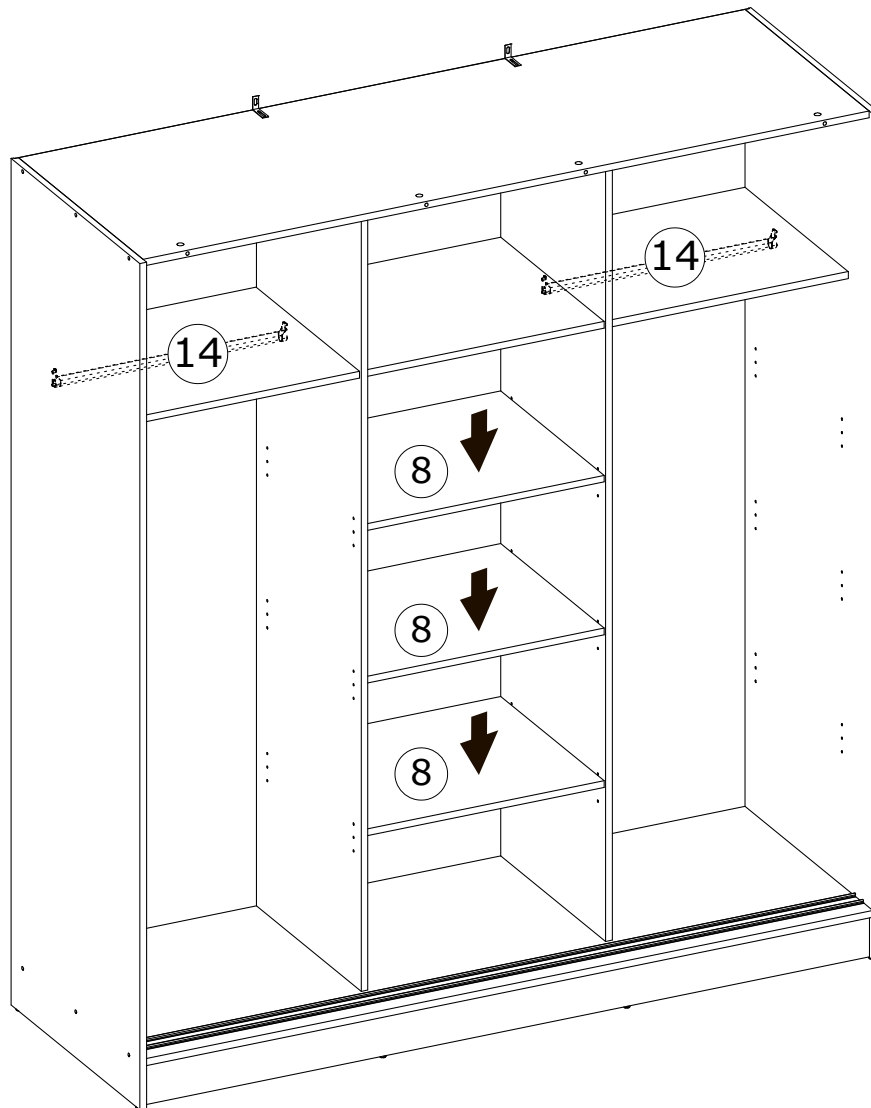
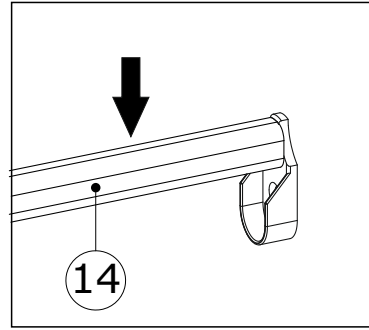
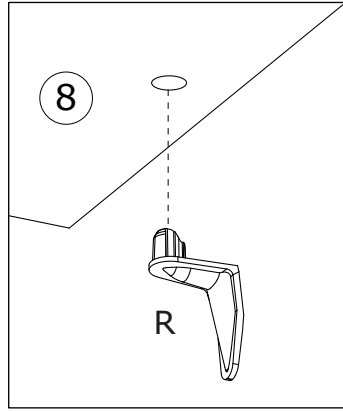

23

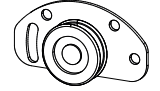
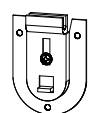
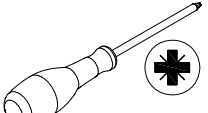

24

W x 12  Ø3,5x16 mm	Y x 8  Ø6,3x13 mm	K x 4  78x44x14 mm	J x 4  71x52x13 mm	
---	--	---	---	---

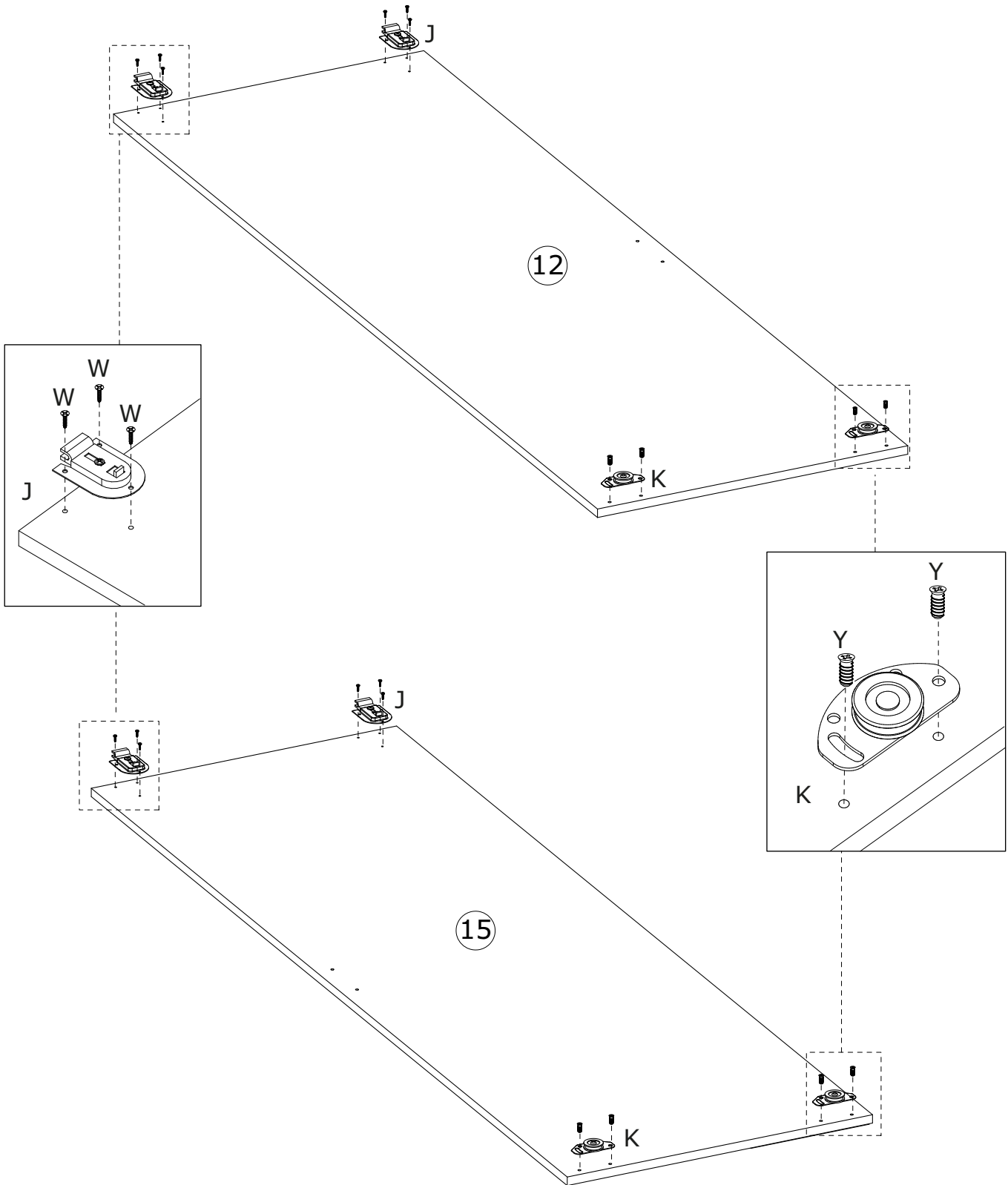

25

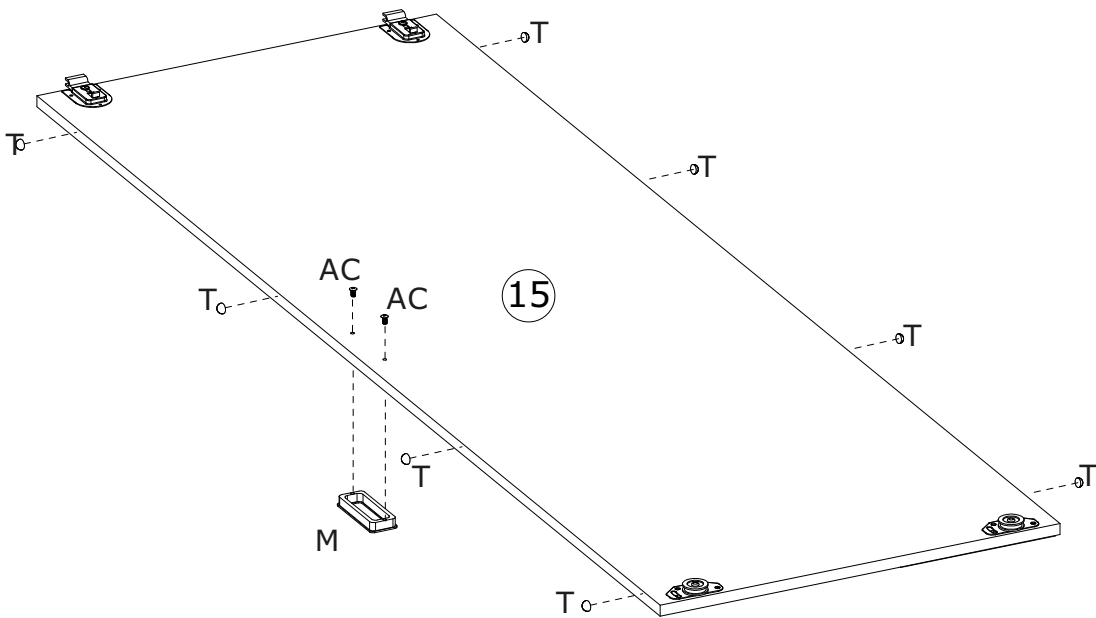
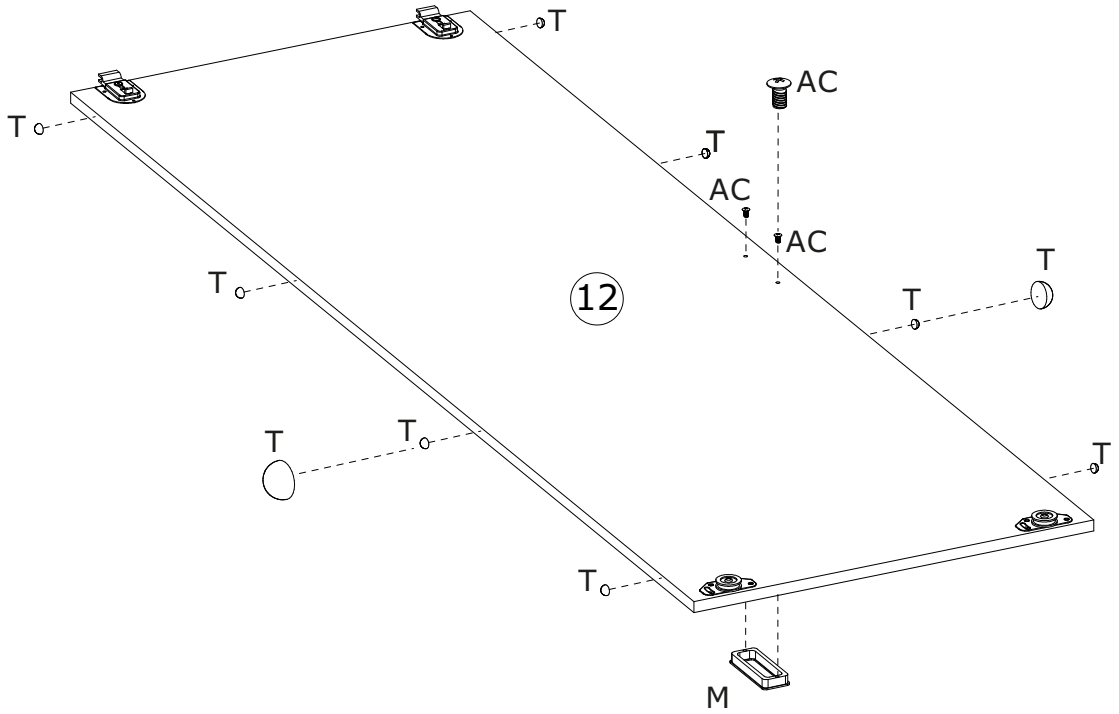

T x 16  Ø8 mm	M x 2  108x42x15 mm	AC x 4  M4x9 mm	
--	--	--	---

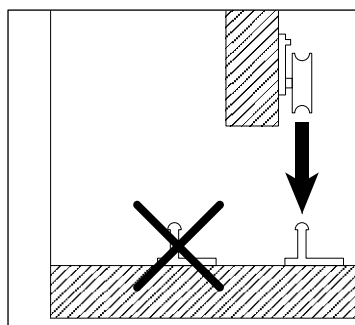
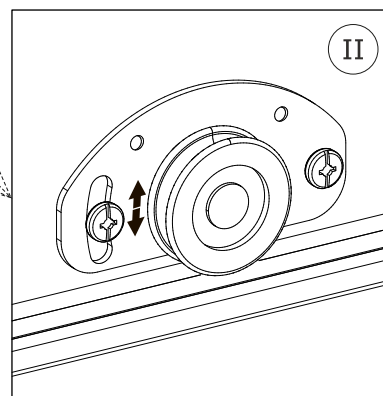
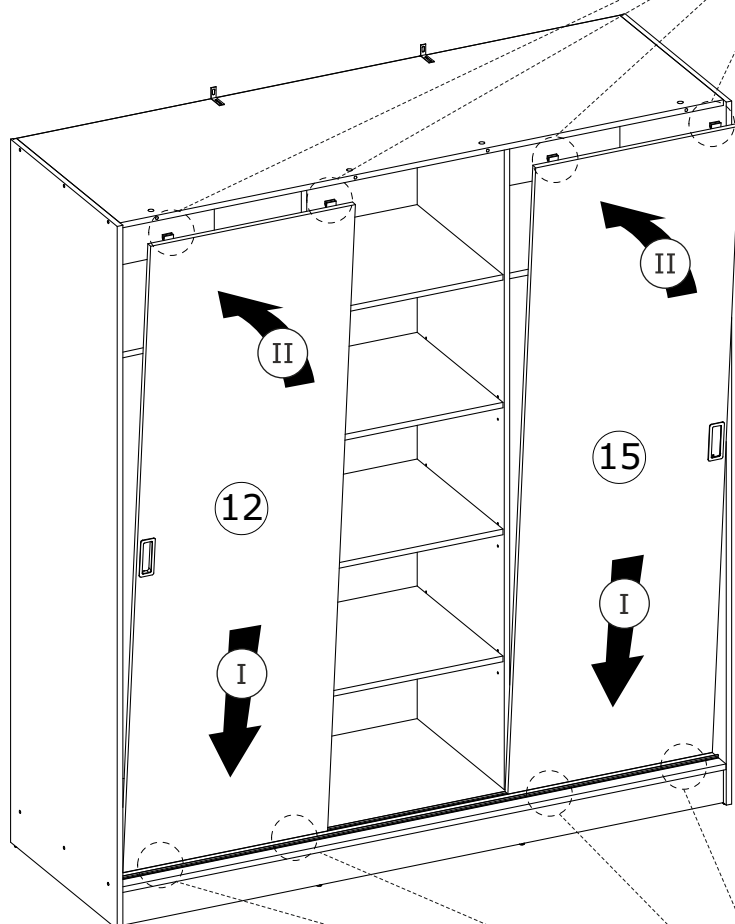
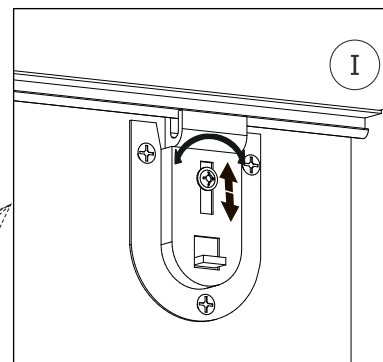
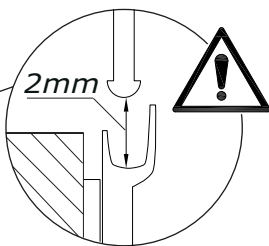
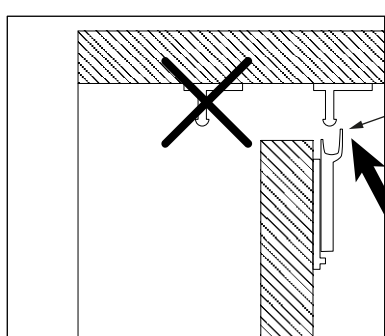
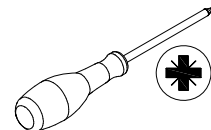

26

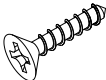

27

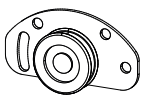
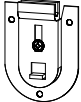
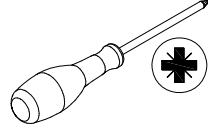
<p>W x 6  Ø3,5x16 mm</p>	<p>Y x 4  Ø6,3x13 mm</p>	<p>K x 2  78x44x14 mm</p>	<p>J x 2  71x52x13 mm</p>	
---	---	--	--	---

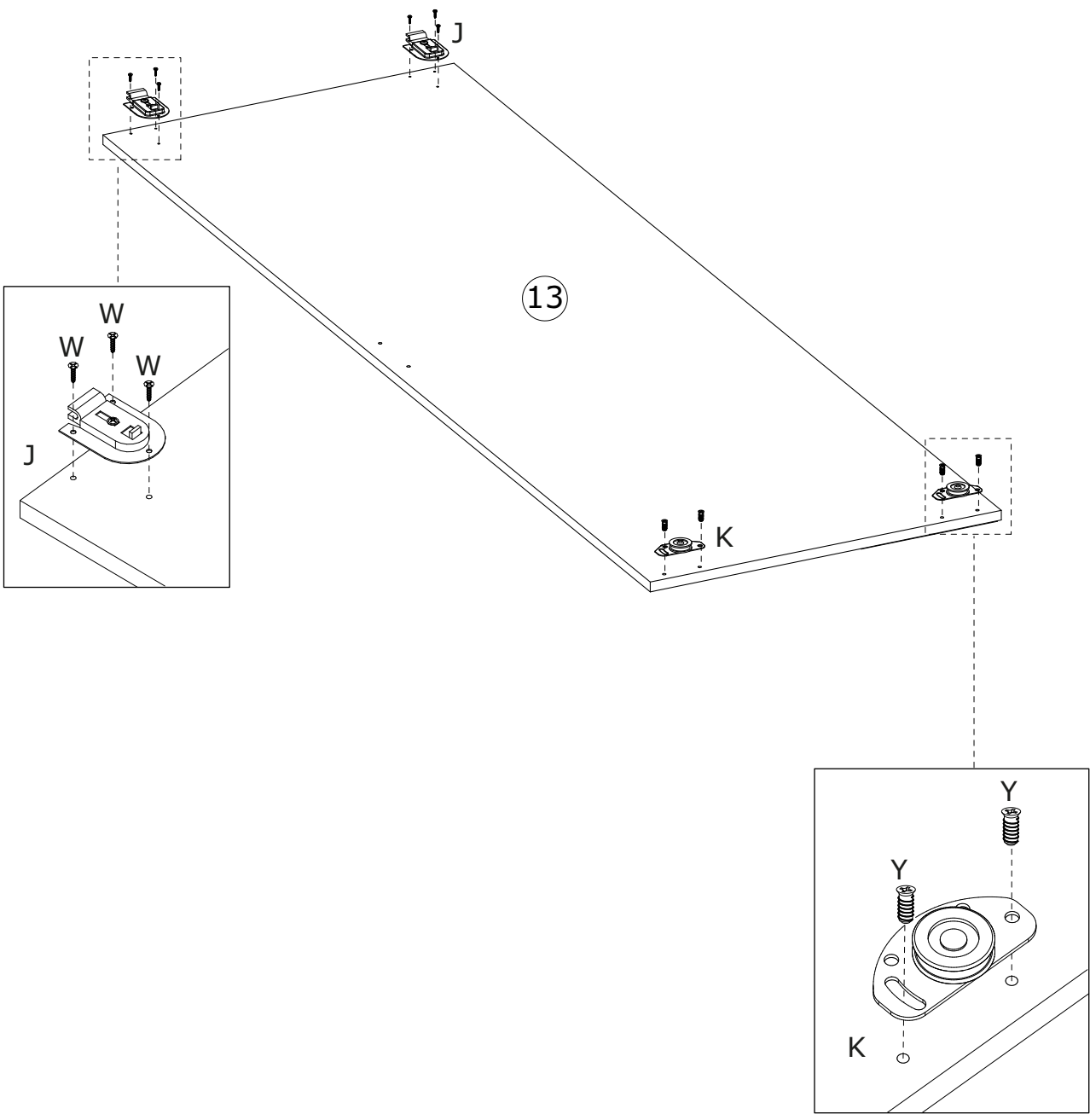

28

T x 8  Ø8 mm	M x 1  108x42x15 mm	AC x 2  M4x9 mm	
---	--	--	---

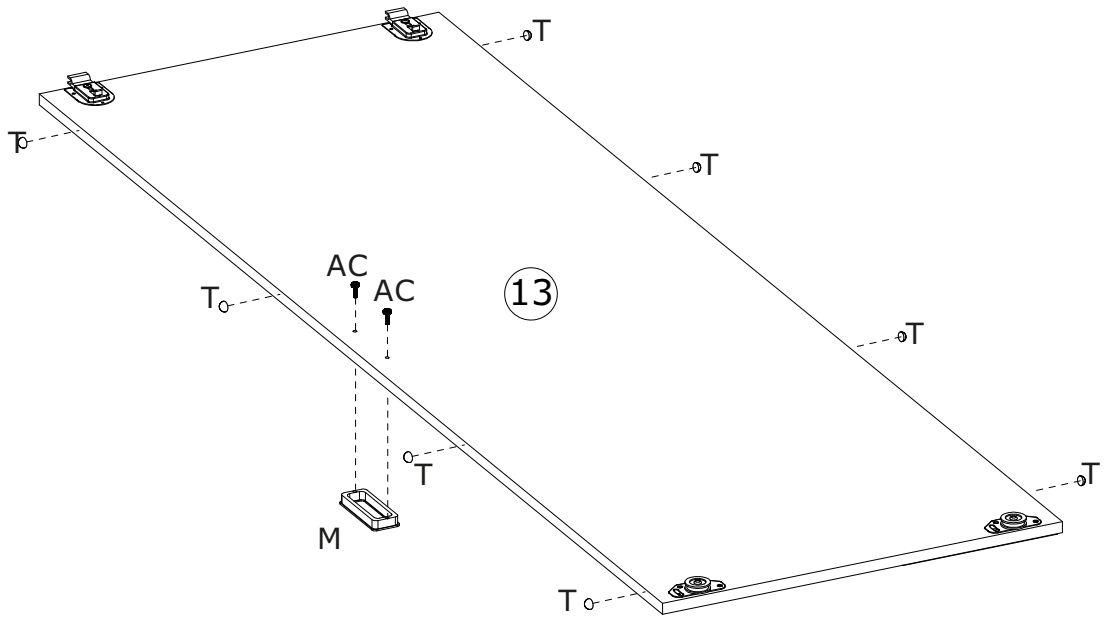

29

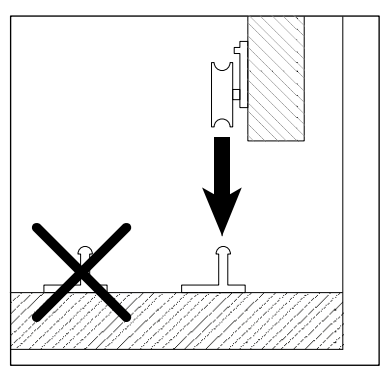
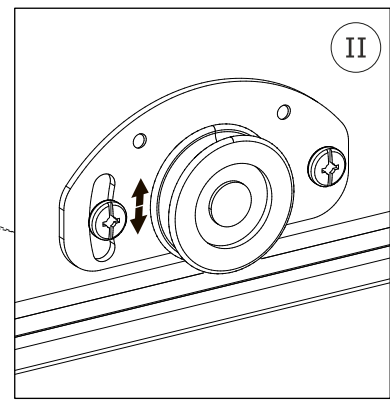
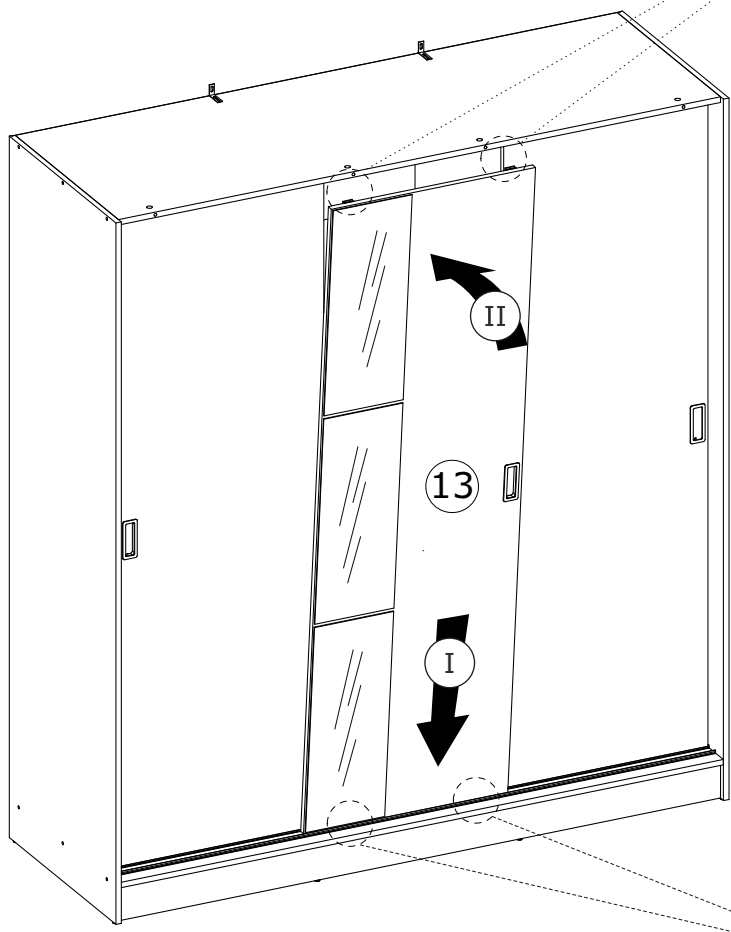
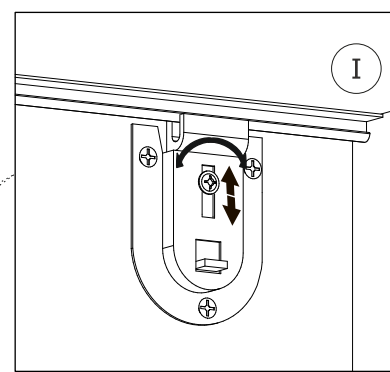
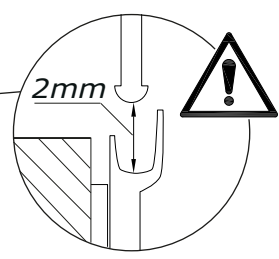
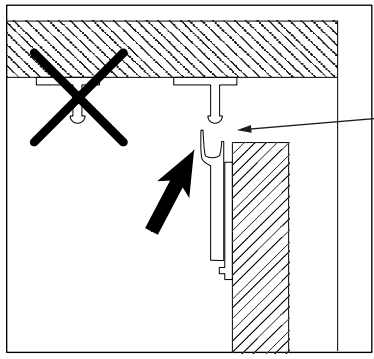
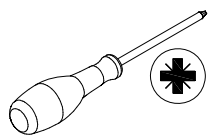

30

<p>A x 4</p>  <p>Ø7x44 mm</p>	
--	---

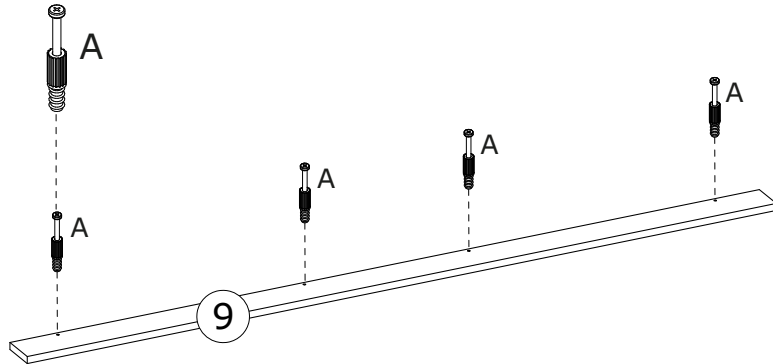

31

<p>B x 4</p>  <p>Ø15x12 mm</p>	
---	---

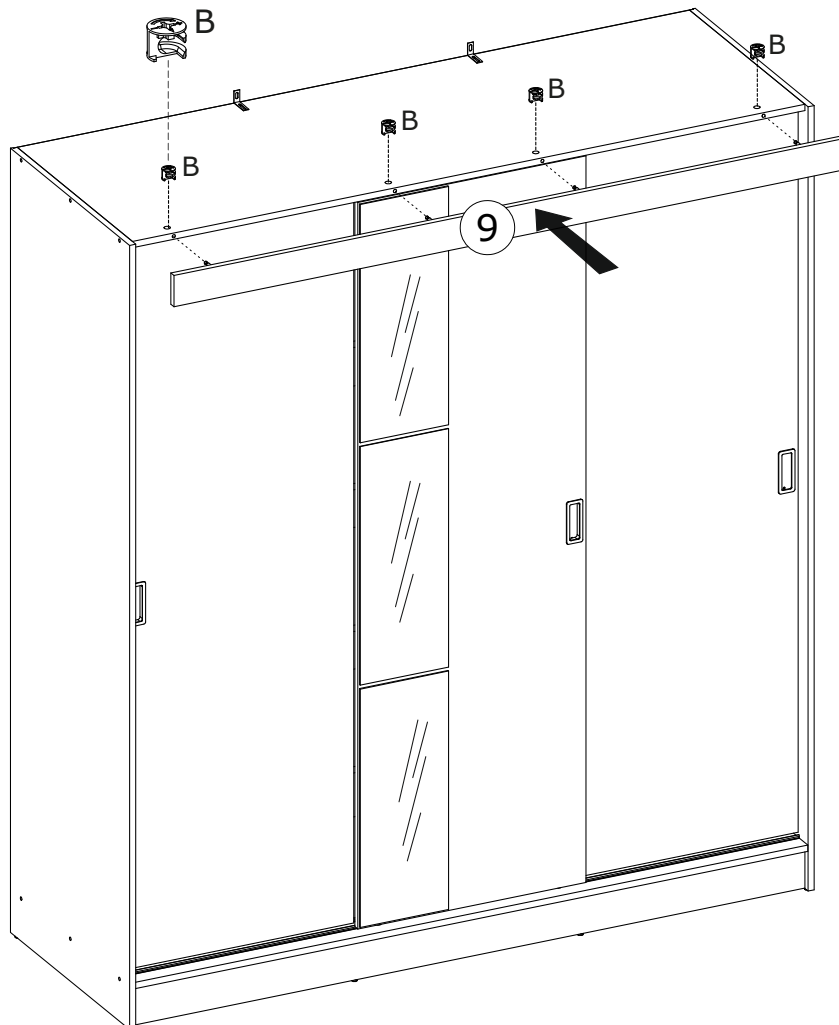

32

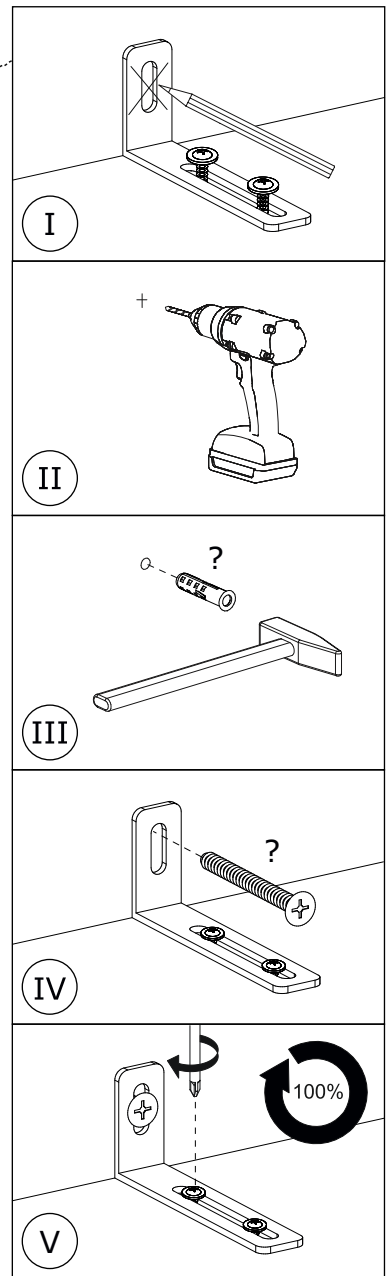
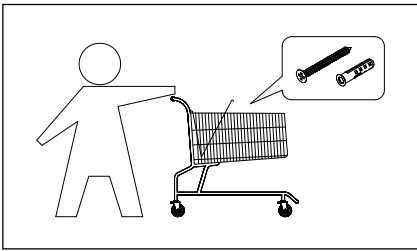
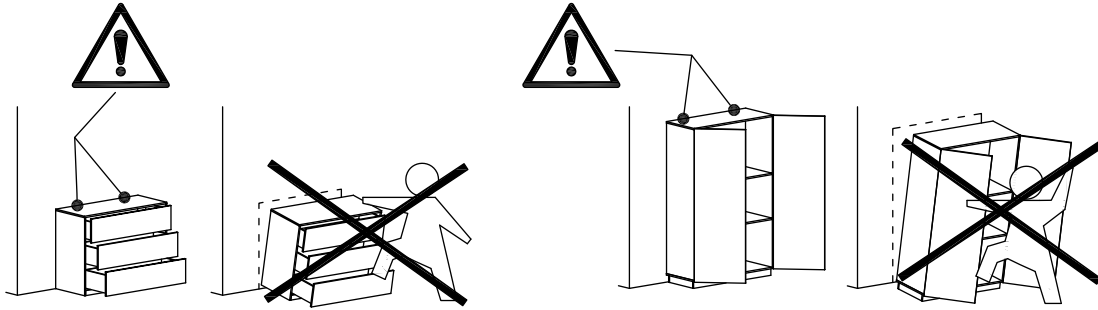
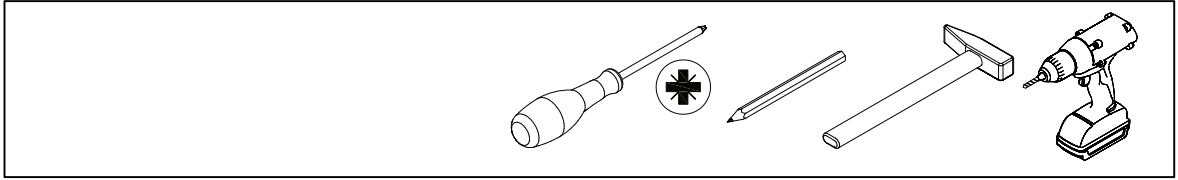

33

Z x 12	
	
Ø14 mm	

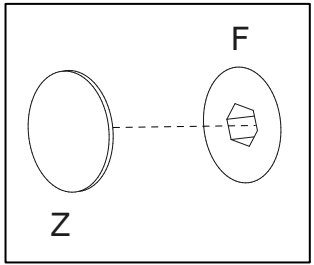
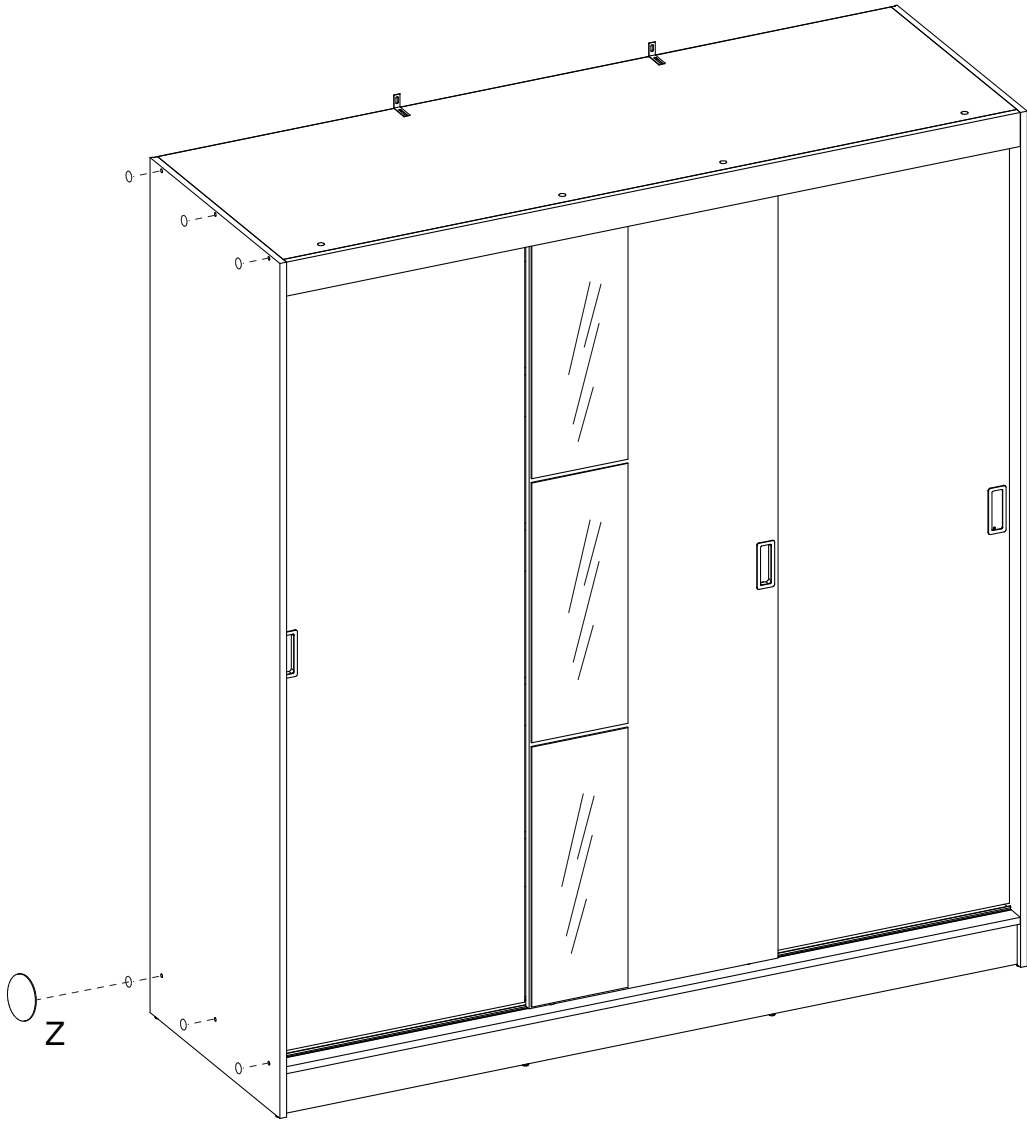

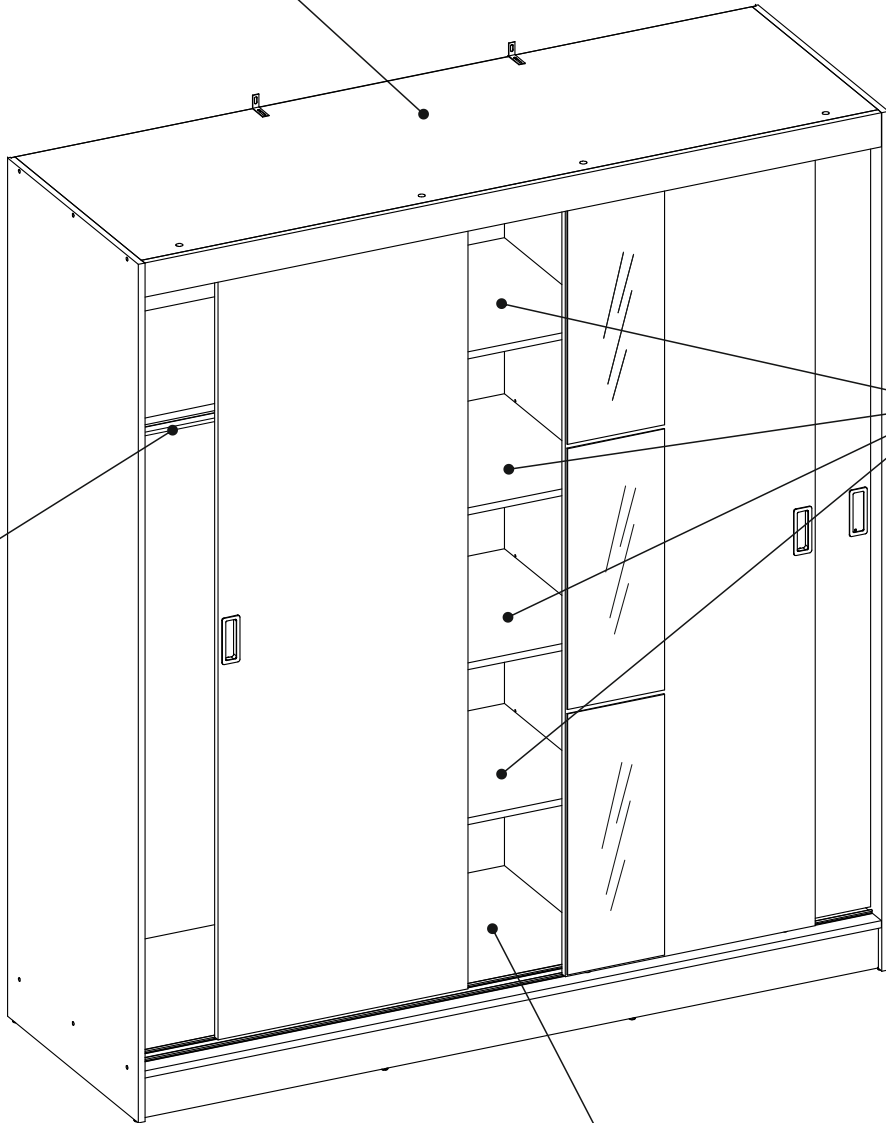

JYSK a/s
Soedalsparken 18
DK 8220 Brabrand
+458939 7500
JYSK.com
DK13590400